

4

3

2

1

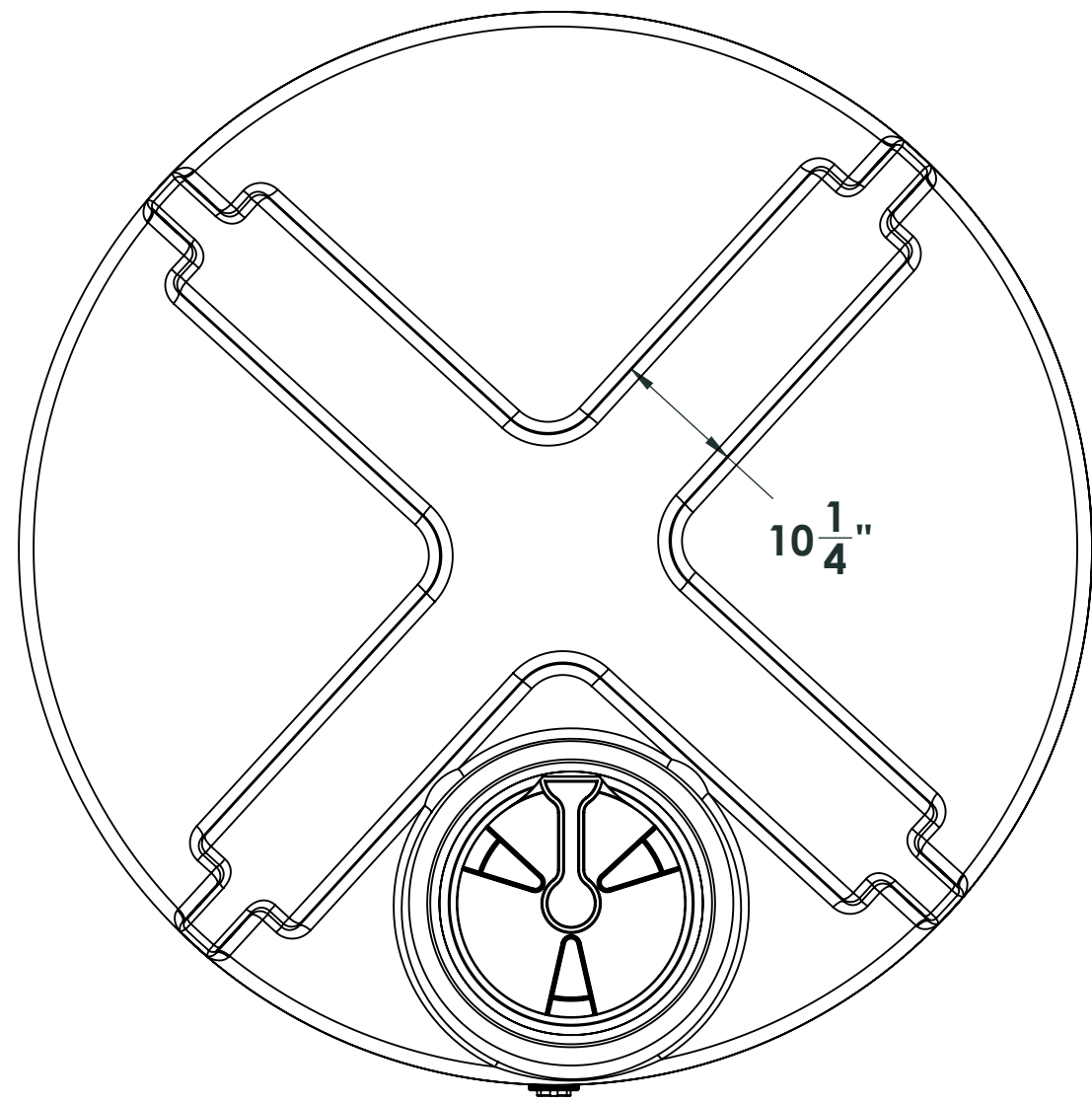

16 inch lid

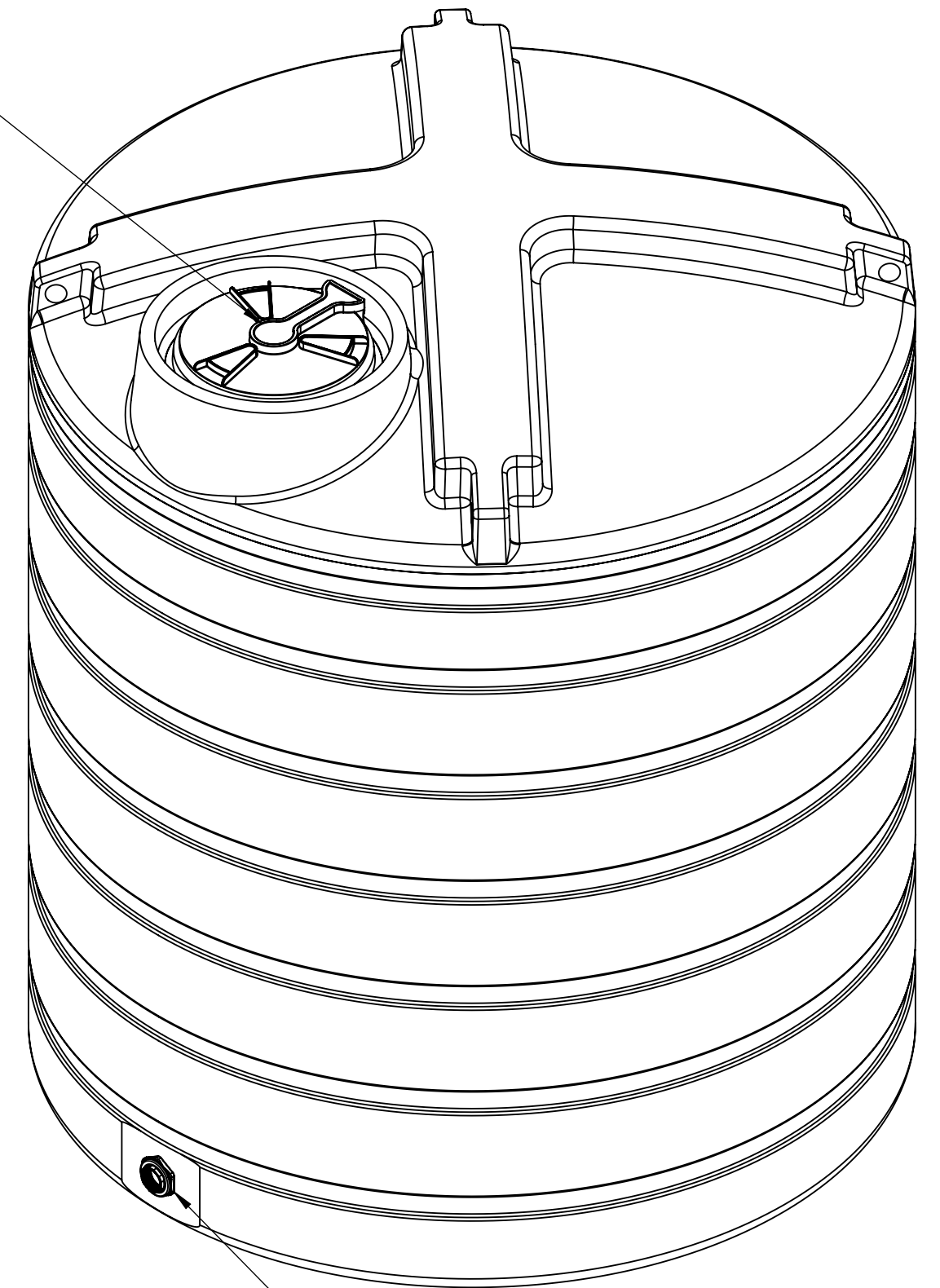

2 inch threaded fitting

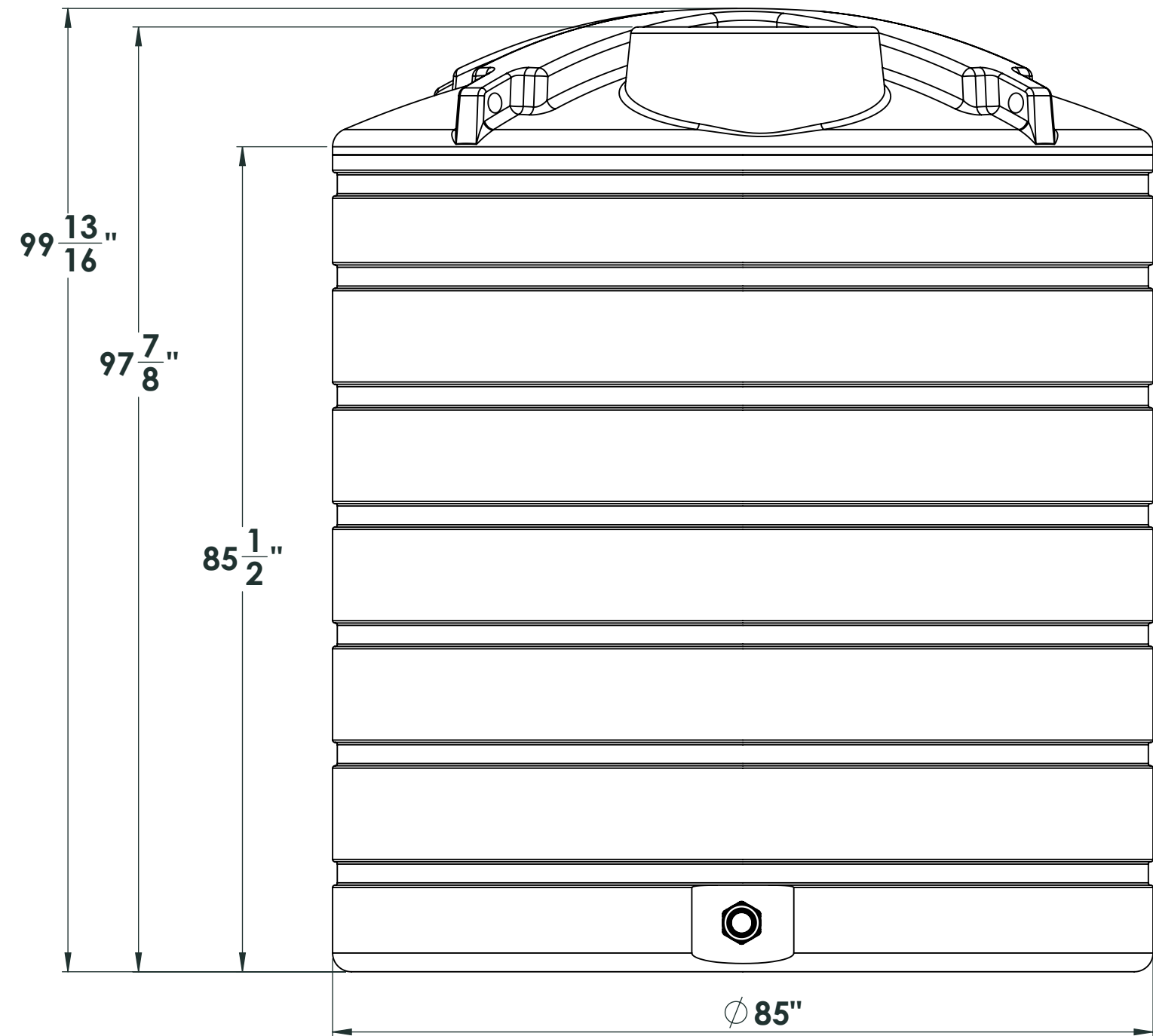

**NOTE: Allow +/- 1.5% Shrinkage**

**PROPRIETARY AND CONFIDENTIAL**  
 THE INFORMATION CONTAINED IN THIS DRAWING IS THE SOLE PROPERTY OF ENDURAPLAS LLC. ANY REPRODUCTION IN PART OR AS A WHOLE WITHOUT THE WRITTEN PERMISSION OF ENDURAPLAS LLC IS PROHIBITED.

		UNLESS OTHERWISE SPECIFIED:		NAME	DATE	ENDURAPLAS LLC	
		DIMENSIONS ARE IN INCHES		DRAWN	DNS	11/1/16	TITLE:
		TOLERANCES:		CHECKED			THV02100
		FRACTIONAL ±		ENG APPR.			SIZE
		ANGULAR: MACH ± BEND ±		MFG APPR.			DWG. NO.
		TWO PLACE DECIMAL ±		Q.A.			REV
		THREE PLACE DECIMAL ±		COMMENTS:			1
		INTERPRET GEOMETRIC TOLERANCING PER:					SCALE: 1:50
		MATERIAL					WEIGHT:
		FINISH					SHEET 1 OF 1
NEXT ASSY	USED ON	APPLICATION		DO NOT SCALE DRAWING			

For more information or to get your questions answered, contact us!  
[www.clarionmunicipal.com](http://www.clarionmunicipal.com) or call us at : (+1) 863-261-8388 | [info@oneclarion.com](mailto:info@oneclarion.com)

4

3

2

1