



Nurse Trailer Accessories

Affordable Customization Options

Why pay for features you won't use? Select only what you want on your nurse trailer from a wide assortment of quality components. Whether you're looking for DOT features, mixing & agitation capabilities, spraying options, added tank access, or needing more power, we have it. With our liquid trailers, you select only the functionality you need. Our trailers are USA-made, quality built, warranted, and affordable. What's more, they're often delivered in weeks, instead having to wait months for your [nurse trailer](#).

- Engines & pumps
- DOT features
- Speed controllers
- Inductors & eductors
- Ladders
- Spray guns
- Nozzles
- Tank options
- Hoses & reels
- Fittings
- Valves
- Trailer options

Need assistance? There's no need to go it alone. Help is just a phone call away. We will walk you through selecting just what you need. Call us today!



Table of Content

PICKUP & TRAILER ACCESSORIES	1
CONE BOTTOM TANKS	2
HOSE REELS	3-4
HOSE CLAMPS & NH3 ASSEMBLIES	5
HOSE	6-8
SPEED CONTROLLER & SPRAY MONITORS	9
SPRAY GUNS	10-11
BOOMLESS NOZZLES	12-17
SPRAY TIPS & NOZZLES	18-19
BOOM COMPONENTS	20-21
VALVES & RINSING NOZZLES	22
EXPRESS WETBOOM	23
NOZZLE BODIES	24-26
THREADED VALVES	27-29
POLY NOZZLE VALVES	30
VALVES	31-32
DRY-MATES, SPIKE & CHECK VALVES.	33
CAM LEVER COUPLINGS & MICRO VALVES	34-35
POLY CAM LEVER COUPLINGS	36-37
POLYPROPYLENE PIPE FITTINGS	38-39
MANIFOLD VALVES	40
MANIFOLD VALVES & FLOW METERS	41
LINE STRAINERS	42-43
POLYPROPYLENE LINE STRAINERS	44
PUSH-TO-CONNECT FITTINGS	45
ENGINES & MOTORS	46
PUMPS	47-60
TRANSFER PUMPS	61-62
CAST IRON, WET SEAL TRANSFER PUMP	63
ELECTRIC CAST IRON, WEST SEAL TRANSFER PUMP	64
CDS-JOHN BLUE SQUEEZE PUMPS	65
IRRIGATION INJECTION PUMP	66
TUBE HOLDERS	67
PRESSURE GAUGEES - SPRAYER, PRESSURE WASH & HYDRAULIC	68
SPRAY MONITORS	69
INDUCTOR / EDUCTOR SYSTEMS	70-73
TANK LIDS	74
TANK FITTINGS	75-77
FLOW DIVIDERS/MANIFOLDS	78
IRRIGATION INJECTION ITEMS	79



PICKUP & TRAILER ACCESSORIES

DOUBLE H HITCH PINS

Made Of High Tensile Steel And Heat Treated With The Red Platisol Head



Part #	Description
H12	1/2" x 3 5/8" long Hitch Pin with clip
H58	5/8" x 5 1/2" long Hitch Pin with clip
H78	7/8" x 6 1/2" long Hitch Pin with clip
H1250	1 1/4" x 8 1/2" long Hitch Pin with clip

LOCKEASE

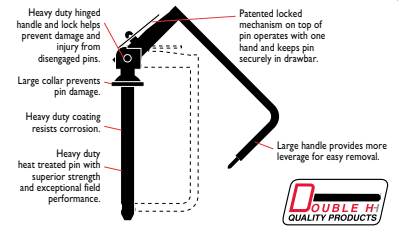

Part #	Shaft Diameter	Usable Length	Per Package	Weight
80140	5/8 "	4-1/2 "	4	2.13
80150	3/4 "	4-1/2 "	4	2.32
80160	3/4 "	6 "	4	2.58
80165	7/8 "	4-1/2 "	4	2.58
80170	7/8 "	6 "	4	2.9
80180	1 "	6 "	4	3.4
80190	1-1/8 "	7 "	4	4.62
80200	1-1/4 "	7 "	4	5.2
80210	1-1/2 "	8 "	2	7.4
80005	Repair Kit*		1	0.11

MILLER HITCH PINS

Part #	Description
HP344	3/4" x 4" long Hitch Pin with clip
HP346	3/4" x 6" long Hitch Pin with clip
HP786	7/8" x 6" long Hitch Pin with clip
HP1006	1" x 6" long Hitch Pin with clip
HPCLIP9	Hitch pin CLIP only # 9 Large
HPCLIP11	Hitch pin CLIP only # 11 Small



BULLDOG JACKS

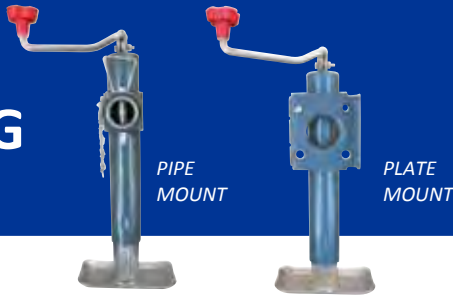

Part #	Lift Cap	Description
2000PIJ10	2000#	Pipe mount jack 10" travel
*2000PIJ15	2000#	Pipe mount jack 15" travel
2000PLJ10	2000#	Plate mount jack 10" travel
*2000PLJ15	2000#	Plate mount jack 15" travel
5000PIJ15	5000#	Pipe mount jack 15" travel
5000POJ15	5000#	Post mount jack 15" travel
**7000PIJ15	7000#	Pipe mount jack 15" travel

*Replacement jacks for 1025 & 1010 nurse trailer & double cone bottom
**Replacement jacks for 8500 series sprayer

AM-S-C SERIES



Part #	Description
AMSC2	Ball Mount
AMSC4	Ball Mount

STANDARD BALL MOUNT



Part #	Hole Size	Drop	Rise	Length	LBS Capacity
BM2	1"	2"	-	8"	5000
BM4	1"	4"	2"	8"	5000
BM2HD	1 1/4"	2"	-	9"	9000
BM4HD	1 1/4"	4"	-	9"	9000

STANDARD HITCH BALLS

Part #	Ball Size	Shank Diameter	Shank Length	Finish	Capacity
BALL25161	2 5/16"	1"	2"	zinc	6,000
2516-114	2 5/16"	1 1/4"	2 1/4"	zinc	10,000



RATCHET & STRAP ASSEMBLIES

Part #	Capacity	Length	Strap Width
R35S	3,000	5'	1"
R39S	3,000	9'	1"
40R20S	2,400	20'	1"
6R27FH	6,000	27'	2"
10R27FH	10,000	27'	2"
12R27FH	12,000	27'	2"

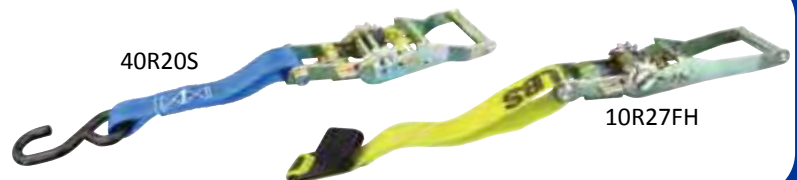

CONE BOTTOM TANKS

ACCESSORIES



Part #	Description
5274288	Hand Pump
HP121-K	Hand Pump Seal Kit
5274298-BLU	Tie Down Rod



ALSO AVAILABLE:
PORTABLE TRIPLE CONE BOTTOM TRAILERS

POLY & STEEL CONE BOTTOM STANDS & TIE DOWNS

Poly Cone Bottom Stands

1050, 1600, 2500, 3000

- Norwesco Poly Stand Available – See Availability Key

Steel Cone Bottom Stands

2500, 3000, 5500, 6000, 7500

- Norwesco Steel Stand Available – See Availability Key

Part #	Description
5274273-BLU	Cone Bottom Stand 15 degree - 91" Diameter for 1020, 1320, 1720, 2500 & 3000 Cone Tanks
5278923-BLU	1020 Cone Tank Tie Down Rod
5278924-BLU	1320 Cone Tank Tie Down Rod
5278943-BLU	1720 Cone Tank Tie Down Rod
5278944-BLU	2500 Cone Tank Tie Down Rod
5274298-BLU	3000 Cone Tank Tie Down Rod



5274273-BLU

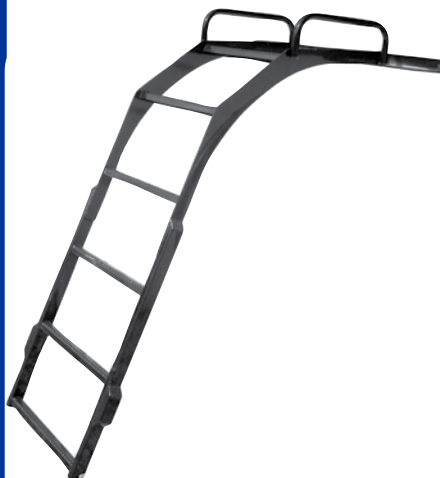

LADDERS & SKIDS

Ladders are available to bolt on the 2610 and 3210 drainable tank for easy lid access. Skids are available to fit all sizes of drainable leg tanks. Rugged steel frames are designed to contour to the drainable tanks unique floor slope. Call for more information.

Part #	Description
FC8-1610	8" 1610 Standard Skid
FC10-2610	10" 2610 Standard Skid
FC10-3210	10" 3210 Standard Skid
FC2610ELLADDER	2610 Elliptical Tank Ladder
5301133	3210 Elliptical Tank Ladder



LOW PRESSURE COX REEL

- Heavy duty 1/4" plate steel support post and mounting plate
- 1" Oil-lite self lubricating bearing
- Solid 1" steel center support shaft
- Full flow swivel joint
- Adjustable arm guide (wall, floor, ceiling and pit)
- Cartridge style spring motor
- 4 Roller non-snag hose guide
- Eight position locking ratchet



Part #	Code #	Hose ID	Hose OD	Ft	PSI
P-LP-350	5274152	3/8"	21/32"	50	300
P-LP-415	5274153	1/2"	27/32"	15	300

COX HAND CRANK REEL



Part #	Code #	Inlet/Outlet	Reel Capacity In Feet	PSI
1125-4-325	5274304	1/2"	450' of 3/8" 325' of 1/2"	3000

COX 12 VOLT ELECTRIC REEL (GEAR DRIVEN)



Part #	Code #	Inlet/Outlet	Reel Capacity In Feet	PSI
1125-4-325E	5274305	1/2"	450' of 3/8" 325' of 1/2"	3000

1526-17-18

- 1/2 FNPT Inlet & Outlet
- Holds 300 Ft of 1/2" ID. x 7/8" OD. Hose
- 3000 PSI Max. Pressure
- Temperature Range -20° to 400°
- Optional Guide Rollers & Mounting Bracket



Reel Shown with Optional Spool Kit, Reel Stand & Hose

Part #	Shipping Bundle #	Description	Weight
1526-17-18	5272182	Hannay Manual Rewind Hose Reel	38

Crank is Permanently Attached to the Reel Axle on this Model

GENERAL PUMP HAND CRANK REEL



Part #	Code #	Inlet/Outlet	Reel Capacity In Feet	PSI
D30006	5277374	3/8" NPT-M 3/8" NPT-F	200' of 3/8"	3500

1" HOSE MANUAL REWIND HOSE REEL



Shown on PCO-200 Skid Page 29

Part #	Description
4038-17-18	1" Hose Manual Rewind Hose Reel, 100' Capacity

MOUNTING STAND FOR HOSE REEL



Part #	Description
5274195	Mounting Stand for Hose Reel

E-Z REEL & E-Z REEL PRO HOSE REEL

- 12VDC Electric Motor Rewind
- Manual Hand Crank Included
- Vertical & Horizontal Guide Tubes
- Chain Guard
- Manual Clutch Lockout for Easy Unwind
- Wireless Remote - Key fob
- Mounted Control Switch
- 316 Stainless Steel Swivel w/ Flange Connections

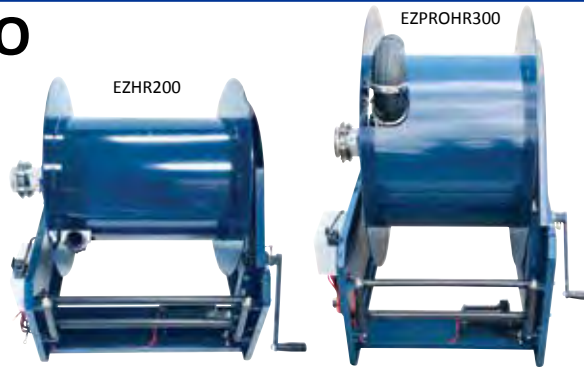

Swivel w/ Flange Connections



Wireless Remote



E-Z Reel Guide Roller

Part #	Description	Dimensions	Hose Capacity
EZHR200	2" E-Z Electric Hose Reel	25 1/4" W X 28" L	75' of 2" Ribbed Hose
EZPROHR300	3" E-Z Pro Electric Hose Reel	25 1/4" W X 42" L	75' of 3" Ribbed Hose

E-Z Reel Optional Equipment

5281390 E-Z Reel Guide Roller Assembly
(Recommended if hose drop over 40")

2" & 3" E-Z HOSE REEL KITS

- 2" or 3" EZ Series Hose Reel
- 50 FT KF2" or 3" 390 Hose
- Hose end valve
- Valve carrying handle
- Male or Female Quick Coupler
- Safety Bump Plug or Cap



Shown with optional 5281390 E-Z Guide Roller

Part #	Description
EZHR200-50-F-*-KIT	2" EZHR200 hose reel, 50' KF2390 hose, T-bolt hose clamps, 2" full port flanged valve, HD valve Handle, *2" MALE or Female quick coupler, GTX flange clamps & Dust Cap or Plug w/ built in handle. (220 Series Flange Inlet) (*Specify Male or Female hose end coupler)
EZHR300-50-F-*-KIT	3" EZPROHR300 hose reel, 50' KF3390 hose, T-bolt hose clamps, 3" flanged valve, HD valve Handle, 3" MALE or Female quick coupler, GTX flange clamps & Dust Cap or Plug w/ built in handle. (300 Series Flange Inlet) (*Specify Male or Female hose end coupler)

2" & 3" EZ HOSE REEL TRAILER PACKAGES

- Universal Trailer Mounting Bracket
- 2" or 3" EZ Series Hose Reel
- 50 FT KF2" or 3" 390 Hose
- Hose end valve
- Valve carrying handle
- Male or Female Quick Coupler
- Safety Bump Plug or Cap



CAN BE RETROFITTED ONTO EXISTING TRAILERS OR BE INSTALLED ON A NEW TRAILER

Part #	Description
EZHR200-TRLMT-50-*-KIT	2" EZ hose reel, Universal Trailer mount kit, 50FT kf2390 hose, 2" valve w/Male or Female QC and Handle Cap or Plug (*Specify Male or Female hose end coupler)
EZHR300-TRLMT-50-*-KIT	3" EZ hose reel, Universal Trailer mount kit, 50FT kf3390 hose, 3" valve w/Male or Female QC and Handle Cap or Plug (*Specify Male or Female hose end coupler)

HOSE CLAMPS & NH3 ASSEMBLIES



CUSTOM SIZES AVAILABLE,
PLEASE CALL FOR PRICING

1" PRE-COUPLED NH3 ASSEMBLIES

Part #	Size x FT
NH31NY3G	1" x 3'
NH31NY4G	1" x 4'
NH31NY5G	1" x 5'
NH31NY6G	1" x 6'
NH31NY7G	1" x 7'
NH31NY8G	1" x 8'
NH31NY9G	1" x 9'
NH31NY10G	1" x 10'
NH31NY12G	1" x 12'
NH31NY15G	1" x 15'
NH31NY20G	1" x 20'
NH31NY25G	1" x 25'
NH31NY30G	1" x 30'

1-1/4" PRE-COUPLED NH3 ASSEMBLIES

Part #	Size x FT
NH3114NY3G	1-1/4" x 3'
NH3114NY4G	1-1/4" x 4'
NH3114NY5G	1-1/4" x 5'
NH3114NY6G	1-1/4" x 6'
NH3114NY7G	1-1/4" x 7'
NH3114NY8G	1-1/4" x 8'
NH3114NY9G	1-1/4" x 9'
NH3114NY10G	1-1/4" x 10'
NH3114NY12G	1-1/4" x 12'
NH3114NY15G	1-1/4" x 15'
NH3114NY20G	1-1/4" x 20'
NH3114NY25G	1-1/4" x 25'
NH3114NY30G	1-1/4" x 30'
NH3114NY40G	1-1/4" x 40'

2" PRE-COUPLED NH3 ASSEMBLIES

NH32NY2G	2" x 2'
NH32NY9G	2" x 9'

T-BOLT CLAMPS



Part #	Size	Min/Max Dia
BJTC130	1 1/4"	1.30"/1.70"
BJTC150	1 1/2"	1.50"/1.75"
BJTC162	1 1/4"	1.62"/1.87"
BJTC181	1 1/2"	1.81"/2.06"
BJTC193	1 1/2"	1.93"/2.18"
BJTC218	2"	2.18"/2.50"
BJTC224	2"	2.24"/2.58"
BJTC231	2"	2.31"/2.62"
BJTC250	2"	2.50"/2.81"
BJTC287	2"	2.87"/3.18"
BJTC331	3"	3.31"/3.62"
BJTC343	3"	3.43"/3.75"
BJTC425	4"	4.25"/4.56"
BJTC438	4"	4.38"/4.75"
BJTC456	4"	4.56"/4.94"

- All stainless steel construction • 360° sealing surface • Steel nut with coating to prevent seizing (will rust) • Ideal for high torque applications • Strong, positive connections where ordinary hose clamps fail • Nylon lock feature • T-bolt design • 3 spot welds for extra strength • Burst pressure to 10,000 PSI

SPEEDY CLAMPS

Part #	Fits Hose Size
F	Small 3/8"
G	Large 3/8"
H	1/2"



Clamp the SPEEDY clamp on EVA and rubber spray hose with a pliers for a snug fit. Push side ways to unclamp.

HOSE & CABLE TIES - BLACK NYLON TIE STRAPS



Part #	Length	Tensile	Bag Qty
NS4	4	18 lb	100
NS6	6	30 lb	100
NS8	8	30 lb	100
NS11	11	50 lb	100
NS14	14	50 lb	100
NS21	21	175 lb	100
NS30	30	175 lb	100

1" PETROLEUM TRANSFER HOSE



Bulk 1" Petroleum transfer hose. (Order by the foot.)



Part #	Description
FARM1	1" petroleum bulkhose

WORM DRIVE CLAMPS STAINLESS STEEL



Part #	Min/Max Diameter
M4	1/4
M5	1/4 - 11/16
M6	5/16 - 7/8
M8	3/8 - 1
M10	1/2 - 1 1/16
M12	1/2 - 1 1/2
M16	11/16 - 1 1/2
M20	3/4 - 1 3/4
M24	1-2
M28	1 1/2
M32	1 1/2 - 2 1/2
M36	1 3/4 - 2 3/4
M48	2 1/2 - 3 1/2
M56	3 - 4
M72	3 - 5

All worm clamps standard packaging 10 per box.

Miniature clamps M4, M5, M6 & M8 come with a 5/16" 301 stainless steel band and housing and 1/4" hex slotted 410 stainless steel screw. M10 thru M72 clamps come standard with 1/2" 301 stainless steel band and housing and 5/16" hex slotted 305 stainless steel screw.

KANAFLEX 390 SD / SUCTION & DISCHARGE HOSE

Part #	Size	PSI	Reel Size	Recommended T-Bolt Clamp Size
KF114390	1 1/4"	100	100'	TC162
KF112390	1 1/2"	100	100'	TC181
KF2390	2"	100	100'	TC224/TC231
KF3390	3"	90	100'	TC343



EXCELLENT CHOICE

fabric reinforced to prevent elongation

Kanaflex 390 is an excellent all-weather suction/discharge hose • Use it where pressure is a factor. • Up to 50% lighter than conventional rubber hose • Highly resistant to temperature changes and deterioration by sun, ozone or mildew • Flexible in low temperature - Lends itself to working in tight spaces • EPDM tube with a thermal plastic helix for full suction • BLACK

KANAFLEX 300 SD / FERTILIZER SOLUTION EPDM TUBE - PVC HELIX

Part #	Size	PSI	Reel Size	Recommended T-Bolt Clamp Size
KF1300	1"	50	100'	-
KF114300	1 1/4"	50	100'	TC150
KF112300	1 1/2"	50	100'	TC181
KF2300	2"	50	100'	TC218
KF3300	3"	43l	100'	TC331
KF4300	4"	38	100'	TC438



100' rolls of 2" & smaller UPSable

Kanaflex 300 is an excellent all-weather suction hose • Good for low pressure usage • Lightweight - low Cost • Highly resistant to temperature changes and deterioration by sun, ozone or mildew • Flexible in low temperature - 100% EPDM tube - polyethylene helix • Smooth I.D. for maximum flow rates • GREEN & BLACK.

PVC SUCTION HOSE CLEAR WITH WHITE HELIX / CL112

Part #	Size	PSI	Reel Size	Recommended T-Bolt Clamp Size
PVC34	3/4"	85	100'	-
PVC1	1"	85	100'	-
PVC114	1 1/4"	80	100'	TC130/TC150
PVC112	1 1/2"	70	100'	TC162
PVC2	2"	65	100'	TC206
PVC250				
PVC3	3"	55	100'	TC312



Kanaflex CL112 is a high quality, flexible, long lasting PVC suction and discharge hose ideally suited for GENERAL purpose water suction • Smooth bore combined with smooth bending characteristics, makes for the fastest, most efficient transfer of fluids • Not chemical resistant • Clear tube with a white spiral.

AG SUCTION HOSE - BLACK EPDM RUBBER WITH STEEL WIRE BRAID

Part #	Size	PSI	Reel Size	Recommended T-Bolt Clamp Size
AGSUC114	1 1/4"	125	100'	TC162
AGSUC112	1 1/2"	125	100'	TC181
AGSUC2	2"	125	100'	TC224
AGSUC3	3"	90	100'	TC331
AGSUC4	4"	75	100'	TC438



EXCELLENT CHOICE

Ag suction is a general purpose suction hose for agricultural use • Weather and ozone resistant EPDM rubber • Black EPDM rubber tube with reinforced spiraled high tensile textile cords • Spiral wire construction to withstand suction and prevent collapsing • Chemical resistant.

CHEMFLEX ACID & CHEMICAL TRANSFER HOSE

Part #	Size	PSI	Reel Size	Recommended T-Bolt Clamp Size
CF1	1"	200	100'	TC150
CF114	1 1/4"	200	100'	TC162
CF112	1 1/2"	200	100'	TC181
CF2	2"	200	100'	TC231
CF3	3"	150	100'	TC343



Chemflex is an economical, versatile chemical transfer hose for use at docks, terminals and on transfer trucks • At normal storage temperatures, up to 90% of all known chemicals, plus solvents, acids, alkalis, oils, fuels and hydraulic fluids can be safely handled by Chemflex. • Constructed of special cross-linked polyethylene tube reinforced with plies of braided synthetic yarn with helix of spring wire • The EPDM cover is resistant to many chemicals, acids, weather and abrasion.

EVA TUBING 1/8" WALL

Part #	Size	Approx Reel Size	Cost
EVA14	1/4" x 1/8" wall	300'	Call For Pricing
EVA38	3/8" x 1/8" wall	500'	Call For Pricing
EVA12	1/2" x 1/8" wall	300'	Call For Pricing
EVA58	5/8" x 1/8" wall	250'	Call For Pricing
EVA34	3/4" x 1/8" wall	250'	Call For Pricing
EVA1	1" x 1/8" wall	100'	Call For Pricing

FULL 18% EVA



Demand the tubing with the BLUE TINT for world class quality and service

REINFORCED EVA TUBING

Part #	Size	PSI	Approx Reel Size
EVA14RE	1/4"	300	300'
EVA38RE	3/8"	250	300'
EVA12RE	1/2"	200	300'
EVA58RE	5/8"	200	200'
EVA34RE	3/4"	200	300'
EVA1RE	1"	200	200'



Reinforced EVA is extremely tough, with very good stress crack resistance at low temperatures. Use reinforced EVA for higher pressure rating than EVA tubing.

CLEAR VINYL TUBING - SIGHT GAUGE - 1/8" OR 1/4" WALL

Part #	Size	Approx Reel Size
CLV148	1/4" x 1/8" wall	100'
CLV388	3/8" x 1/8" wall	100'
CLV128	1/2" x 1/8" wall	100'
CLV588	5/8" x 1/8" wall	100'
CLV348	3/4" x 1/8" wall	100'
CLV18	1" x 1/8" wall	100'
CLV1144	1 1/4" x 1/4" wall	50'
CLV1124	1 1/2" x 1/4" wall	50'
CLV24	2" x 1/4" wall	50'



Clear vinyl hose is excellent for sight gauge and by pass applications. Designed for low working pressure.

CLEAR VINYL TUBING - SIGHT -GAUGE - 1/16" WALL

Part #	Size	Approx Reel Size
CLV1416	1/4" x 1/16" wall	100'
CLV3816	3/8" x 1/16" wall	100'
CLV1216	1/2" x 1/16" wall	100'



REINFORCED CLEAR VINYL TUBING

Part #	Size	Approx Reel Size
CLV14RE	1/4" x 1/8" wall	300'
CLV38RE	3/8" x 1/8" wall	300'
CLV12RE	1/2" x 1/8" wall	300'
CLV58RE	5/8" x 1/8" wall	300'
CLV34RE	3/4" x 1/8" wall	200'
CLV1RE	1" x 1/8" wall	100'
CLV114RE	1 1/4" x 1/8" wall	50'
CLV112RE	1 1/2" x 1/4" wall	50'



Reinforced CLV is highly flexible. Higher pressure ratings of the reinforced clear vinyl tubing offers a wider range of applications. Excellent for handguns and other sprayer applications.

BLACK RUBBER EPDM SPRAYER HOSE

Part #	Size	PSI	Approx Reel Size
EPDM14	1/4" x 2sp	200	700'
EPDM38	3/8" x 2sp	200	700'
EPDM12	1/2" x 2sp	200	700'
EPDM58	5/8" x 2sp	200	700'
EPDM34	3/4" x 2sp	200	700'
EPDM100	1" x 2sp	150	700'
EPDM114	1 1/4" x 4sp	150	550'
EPDM112	1 1/2" x 4sp	150	400'
EPDM200	2" x 4sp	150	300'



EPDM sprayer hose is an excellent general purpose hose for water and ag chemical applications • EPDM construction of the hose makes it suitable for a wide variety of chemicals including water mixed agricultural sprays • Lasso resistant

PVC 600# SPRAY HOSE

Part #	Size	PSI	Approx Reel Size
PVC38600	3/8"	600	300'
PVC12600	1/2"	600	300'
PVC58600	5/8"	600	300'
PVC34600	3/4"	600	300'



PVC high pressure hose for use with fertilizers, herbicides, and insecticide in both agriculture and lawn spray service • PVC tube and cover • Co-extruded with a single braided synthetic cord

BLUE PVC LAY FLAT DISCHARGE HOSE

Part #	Size	PSI	Approx Reel Size	Recommended T-Bolt Clamp Size
LF112	1 1/2"	70	300'	TC162
LF2	2"	65	300'	TC206
LF3	3"	55	300'	TC312
LF4	4"	50	300'	TC425



Blue PVC lay flat hose is an economical hose for discharging water in construction, agriculture, etc • Resistant to oils, grease and many chemicals and acids • Non water-absorbing • Mildew proof • Tube and cover are PVC and reinforcement is a spiral of high grade cord fabric

IRONSIDE LAY FLAT DISCHARGE HOSE

Part #	Size	PSI	Approx Reel Size	Recommended T-Bolt Clamp Size
IS112	1 1/2"	150	300'	TC162
IS2	2"	150	300'	TC206
IS3	3"	150	300'	TC312
IS4	4"	150	300'	TC425
IS6	6"	150	as needed	



Ironside brown lay flat discharging hose used in construction, irrigation, agriculture, etc • It is superior to the Blue PVC Lay flat in working pressure and gauge thickness • Non water-absorbing • Mildew proof • Tube and cover are premium quality PVC tube and cover • Reinforced with two spiral plies and one longitudinal synthetic cord

GRAIN VAC HOSE

Part #	Size	Vacuum Rating	Approx Reel Size
180BL4	4"	-	100'
180BL5	5"	-	100'
180BL6	6"	-	100'

- Only Available in 5' Increments

- SBR rubber blended with static carbon black
- Rigid PVC helix
- Smooth bore
- Corrugated O.D.
- Light weight
- Discharge Only

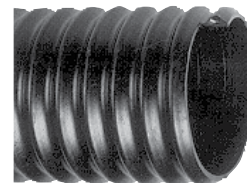

HD GRAIN VAC HOSE USED FOR GRAIN TRANSFER

Part #	Size	Vacuum Rating	Approx Reel Size
180AR5	5"	28	100'

- Only Available in 5' Increments

- SBR rubber blended with static carbon black
- Rigid PVC helix
- Smooth bore
- Corrugated O.D.
- Light weight
- Suction

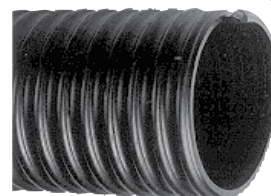

620 WDWS BLOWER HOSE (MOWER)

Part #	Size	Approx Reel Size
620WDWS6	6"	50'

- Only Available in 5' Increments



- EPDM rubber, metal wire helix
- Wearstripping
- Smooth bore
- Corrugated O.D.

HOSE CUTTER

The perfect tool for cutting hose and tubing • Lightweight and easy to use

Part #	Description
T-100	Hose cutter - cuts thru 1" hose
SS200	Hose cutter - cuts thru 2" hose
BT100	Blade for the T100 cutter
SSB200	Blade for the SS200 cutter



SPEED CONTROLLER & SPRAY MONITORS



FLOW MONITORS



Part #	Description
BM1CADW	Flow Monitor, Single Column Add On
BM4RCAW	Flow Monitor, 4 Row Assembly - 3/8" HB
BM6RCAW	Flow Monitor, 6 Row Assembly - 3/8" HB
BM8RCAW	Flow Monitor, 8 Row Assembly - 1/2" HB

UNIVERSAL MOUNTING BRACKET

Part #	Description
CFVGM	Universal Mounting Bracket



12 VOLT PUMP SPEED CONTROLLER

Includes: 12 Volt, 10 amp, 30 amp, speed control • Reverse polarity protected • 8 ft. input wire • 15 ft. output wire • On/off control switch • Speed control adjustment knob

Part #	Description	Use With
500ESCNG-10	10 amp controller with wires & fitting	12 volt diaphragm
MSC10-NG	10 amp controller only, less wiring harness	
500ESCNG	30 amp controller wires & fitting	12 volt diaphragm
MSC-30NG-I	30 amp controller only, less wiring harness	
216012	Implement Switch	



We are here to serve you. Just call or email with your project specifications and details, and we'll do the rest. Our goal is to provide the best solution for your project, with materials delivered on time at a price that fits nicely within your budget.

SPRAY GUNS



22670-PP-24-X8



- Replaceable viton diaphragm
- Trigger lock permits locking valve in open position for continuous flow
- Maximum operating pressure 150 PSI
- 1/4" NPTF inlet connection



5500-PPB-X*



22650PP

Part #	Description
22650-PP-1/4	Gun less tip
22670-PP-24-*	Gun, 24" extension, 5500PPBX8 adj. tip
22670-PP-15-*	Gun, 15" extension, 5500PPBX8 adj. tip
5500-PPB-X**	Poly adjustable ConeJet tip**

*Specify Hose Barb Size **Specify Tip Size

R1ALM



- Gun has built-in strainer in handle.
- Polypropylene body with aluminum lance.
- 3/8" hose barb to connect to a hand gun hose.
- Adjustable plastic cone tip, solid stream to a fog.

Part #	Description
R1ALM	Hand Gun with positive shut-off



MODEL 50800

The 50800 TriggerJet spray gun is a lightweight spray gun designed for use with backpack canister or other low pressure sprayers. The TriggerJet is made of molded polypropylene for excellent chemical resistance and durability.

- Available with 15" polypropylene or 21" aluminum extension wand
- Available with 38720-PP-X18 adjustable ConeJet® spray tips with a 30° offset
- Trigger lock permits locking gun in an open position for continuous flow
- Maximum operating pressure of 100 PSI
- 1/4" or 3/8" hose shank connection
- Approximatel max. hose O.D. - 1/2"
- Polypropylene strainer located inside handle to prevent tip clogging

Part #	Description
50800-15-PP-300	15" polypropylene extension 1/4" hose barb inlet
50800-15-PP-406	15" polypropylene extension 3/8" hose barb inlet
50800-21-AL-300	21" aluminum extension 1/4" hose barb inlet
50800-21-AL-406	21" aluminum extension 3/8" hose barb inlet



LAWN SPRAY GUN

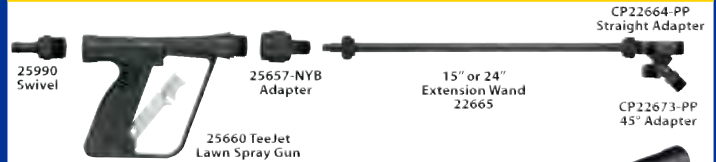

- High impact, corrosion resistant materials Nylon (black), Viton "O"-rings, packings and seat, with SS springs
- Interchangeable nozzle tips are color coded for easy identification of nozzle tip size
- Convenient trigger lock for continuous spraying
- Maximum recommended pressure (150 PSI)



25660-1.5

Part #	Description
25660.*	TeeJet Lawn Spray Gun (w/1 nozzle)
25660-0	TeeJet Lawn Spray Gun (less nozzle)
CP25670-* -NY	Tip for lawn spray gun(1.5, 3.0, 4.0)
25990-3/4-NYB	3/4" Hose shank swivel
25657-NYB	Lawn gun adapter
22665-15-PP	Extension assembly 15" (less tip)
22665-24-PP	Extension assembly 24" (less tip)



5500 ADJUSTABLE CONEJET TIP



5500-X



5500-PPB-X

Part #	Description
5500-X*	Brass Tip
5500-PPB-X*	Polypropylene Tip

*Specify Tip Size

5500 Adjustable ConeJet Tip Available in Brass or Poly		Performance at Pressures Indicated					
Tip No	Performance	20 PSI		30 PSI		40 PSI	
		Settings		Settings		Settings	
		A	B	A	B	A	B
5500-X4	Capacity-GPM	5	.18	.058	.22	.067	.25
	spray angle	61°	---	70°	---	73°	---
	max.throw-ft.	2.5	30	2.5	33	3	34
5500-X5	Capacity-GPM	.061	.21	.076	.26	.082	.30
	spray angle	61°	---	70°	---	74°	---
	max.throw-ft.	2.5	31	2.5	34	3	35
5500-X8	Capacity-GPM	.097	.33	.12	.40	.13	.47
	spray angle	66°	---	71°	---	74°	---
	max.-throw-ft.	3	34	3	37	3	38
5500-X18	Capacity-GPM	.21	.69	.25	.84	.30	.97
	Spray angle	71°	---	75°	---	77°	---
	max. throw-ft.	4	38.4	4	42.1	4	43.5
5500-X26	Capacity-GPM	.31	.98	.37	1.2	.43	1.4
	spray angle	72°	---	76°	---	78°	---
	max.-throw-ft.	4.5	38.1	5	43	5	45

SPRAY GUN MODELS 3381-0010 & 3381-0011



Part #	Description
5163089	3381-0010
5163102	3381-0011

HYPRO®

SPECIFICATIONS:

- **Maximum Pressure:** 1200 PSI
- **Maximum Capacity:** Model 3381-0010 - 25 gpm
Model 3381-0011 - 30 gpm
- **Barrel Length:** Model 3381-0010 - 17"
Model 3381-0011 - 21"
- **Port-NPT:** 1/2" Inlet (M)

(Note: Gun comes equipped with a 1/2" hose barb inlet. Simply remove hose barb for 1/2" male inlet.)

These guns offer long-range capability, which makes them excellent for tree spraying, fire fighting and de-icing. The 3381-0010 comes standard with a 3 mm spray tip; the 3381-0011 comes standard with a 4mm spray tip

SPRAY GUN 3381-0010, 3381-0011 & 3381-0013 TIP PERFORMANCE CHART

HYPRO TIP NUMBER	ORIFICE DIAMETER (mm)	EQUIVALENT NOZZLE NUMBER	PERFORMANCE	ALUMINUM GUN													
				200 PSI		350 PSI		500 PSI		600 PSI		650 PSI		700 PSI		850 PSI	
				Cone	Straight	Cone	Straight	Cone	Straight	Cone	Straight	Cone	Straight	Cone	Straight	Cone	Straight
3385-2300	2.3	14	-10 Flow (GPM)	2.1	2.8	2.7	3.6	3.3	4.4	3.7	4.8	3.9	5	4	5.2	4.4	5.5
			-11 Flow (GPM)	2.8	2.8	3.7	3.7	4.5	4.5	4.9	4.9	5.1	5.1	5.3	5.3	5.7	5.7
			MAX THROW (FT)*	11.4	29	12.9	33.9	14.8	37.9	16.6	41.5	17	41.7	17.7	42	19	45.7
3385-3000 1*	3	23	-10 Flow (GPM)	2.9	5.3	3.8	6.8	4.7	8.1	5.2	8.9	5.4	9.2	5.6	9.6	6.2	10.6
			-11 Flow (GPM)	5.3	5.3	6.8	6.9	8	8.2	8.8	9.1	9.1	9.4	9.4	9.8	10.3	10.7
			MAX THROW (FT)*	11.7	29.2	12.9	33.9	13.8	36.2	15.6	40.8	16	40.7	16.2	42	17	44.1
3385-4000 2*	4	40	-10 Flow (GPM)	4.2	9.5	5.6	12.1	6.8	14.4	7.5	15.8	7.7	16.5	8	17.1	8.7	18.7
			-11 Flow (GPM)	8.1	9.5	10.3	12.2	12	14.6	13	16	13.4	16.7	13.7	17.3	14.5	19
			MAX THROW (FT)*	15.1	37.7	20.6	42.8	24.3	47	27.2	53	27.2	54	28.5	55	29	59
3385-5000	5	67	-10 Flow (GPM)	5.4	13.1	7	16.8	8.4	20.2	9.2	22	9.6	22.8	9.6	23.8	10.7	25.9
			-11 Flow (GPM)	10.2	13.2	12.5	17	14.6	20.4	15.9	22	16.4	23	17	23.6	18.4	25.6
			MAX THROW (FT)*	19.6	40.7	23.8	47	27.5	53.3	32.3	59	32.3	61	32.8	62	32.8	67
3385-6000	6	91	-10 Flow (GPM)	5.9	16.6	7.6	21	8.6	25.6	9.2	27.8	9.6	29	9.7	30.1	10.2	32
			-11 Flow (GPM)	11.3	17.2	14.6	21.6	16.9	25.8	18.6	28.4	19.6	29.6	20.3	30.9	21.9	34.3
			MAX THROW (FT)*	21.1	43.7	25.3	54	30.7	60	35.6	66	35.6	67	36	68	36	74

*Figures shown are guidelines for vertical throw. ** Pressures based on relief valve settings at straight throw.
1* Standard Tip on 3381-0010 & 3381-0013
2* Standard Tip on 3381-0011

TURBO 400 SPRAY GUN MODEL 3381-0013



Part #	Description
5163103	3381-0013

HYPRO®

SPECIFICATIONS:

- **Maximum Pressure:** 700 PSI
- **Maximum Capacity:** 10 gpm
- **Barrel Length:** 7"
- **Port-NPT:** 1/2" Inlet (M)

(Note: Gun comes equipped with a 1/2" hose barb inlet. Simply remove hose barb for 1/2" male inlet.)

This powerful Turbo 400 trigger gun is complete with a standard 3 mm spray tip.

HYPRO® BOOM X TENDER SERIES NOZZLES



THREADED BOOM X TENDERS

Part #	Inlet Port	Color
XT010	1/4" MNPT	GREEN
XT020	1/4" MNPT	BLUE
XT024	1/4" MNPT	YELLOW
XT043	3/8" MNPT	ORANGE
XT080	1/2" MNPT	RED
XT167	3/4" MNPT	WHITE
XT215	3/4" MNPT	GRAY

FEATURES:

- Excellent low drift option with extending spray reach
- Large droplet size reduces spray drift and promotes spray penetration
- Maintains a consistent spray swath of 15-20 feet over a pressure range of 30-60 PSI

THREADED BOOM X TENDERS REPAIR KITS

Part #	Description
XT010-GIOKIT	Pattern Generator, Stainless Steel Insert(s) & Internal O-Rings (if used)
XT020-GIOKIT	Pattern Generator, Stainless Steel Insert(s) & Internal O-Rings (if used)
XT024-GIOKIT	Pattern Generator, Stainless Steel Insert(s) & Internal O-Rings (if used)
XT167-GIOKIT	Pattern Generator, Stainless Steel Insert(s) & Internal O-Rings (if used)
XT215-GIOKIT	Pattern Generator, Stainless Steel Insert(s) & Internal O-Rings (if used)

FAST CAP BOOM X TENDERS



Part #	Color
FC-XT010	GREEN
FC-XT015	LITE GREEN
FC-XT020	BLUE
FC-XT024	YELLOW
FC-XT043	ORANGE

Nozzle Size (MNPT)	Pressure (PSI)	Flow Rate (GPM)	Gallons per Acre at swath shown MPH								GAL/1000Ft ²			Swath (Ft) at 40 PSI 48 in high	
			4	5	6	8	10	12	15	20	2	3	4		5
10 (1/4")	30	0.9	8.9	7.1	5.9	4.5	3.6	3.0	2.4	1.8	0.41	0.27	0.20	0.16	13
	40	1.0	9.9	7.9	6.6	5.0	4.0	3.3	2.6	2.0	0.45	0.30	0.23	0.18	
	50	1.1	10.9	8.7	7.3	5.4	4.4	3.6	2.9	2.2	0.50	0.33	0.25	0.20	
	60	1.2	11.9	9.5	7.9	5.9	4.8	4.0	3.2	2.4	0.55	0.36	0.27	0.22	
15 (1/4")	30	1.3	10.9	8.7	7.3	5.4	4.4	3.6	2.9	2.2	0.53	0.35	0.26	0.21	14
	40	1.5	12.5	10.0	8.3	6.3	5.0	4.2	3.4	2.5	0.61	0.41	0.30	0.24	
	50	1.7	13.7	11.0	9.2	6.9	5.5	4.6	3.7	2.8	0.67	0.45	0.33	0.27	
	60	1.8	15.0	12.0	10.0	7.5	6.0	5.0	4.0	3.0	0.73	0.49	0.37	0.29	
20 (1/4")	30	1.7	13.6	10.9	9.0	6.8	5.4	4.5	3.6	2.7	0.62	0.42	0.31	0.25	15
	40	2.0	16.0	12.8	10.6	8.0	6.4	5.3	4.3	3.2	0.73	0.49	0.37	0.29	
	50	2.2	17.6	14.1	11.7	8.8	7.0	5.9	4.7	3.5	0.81	0.54	0.40	0.32	
	60	2.4	19.2	15.3	12.8	9.6	7.7	6.4	5.1	3.8	0.88	0.59	0.44	0.35	
24 (1/4")	30	2.1	16.2	13.0	10.8	8.1	6.5	5.4	4.3	3.2	0.75	0.50	0.37	0.30	16
	40	2.4	18.6	14.9	12.4	9.3	7.4	6.2	5.0	3.7	0.85	0.57	0.43	0.34	
	50	2.7	20.9	16.7	13.9	10.4	8.4	7.0	5.6	4.2	0.96	0.64	0.48	0.38	
	60	2.9	22.4	17.9	15.0	11.2	9.0	7.5	6.0	4.5	1.03	0.69	0.51	0.41	
43 (3/8")	30	3.7	31.6	25.3	21.1	15.8	12.6	10.5	8.4	6.3	1.45	0.97	0.72	0.58	14
	40	4.3	36.7	29.4	24.5	18.3	14.7	12.2	9.8	7.3	1.68	1.12	0.84	0.67	
	50	4.8	41.0	32.8	27.3	20.5	16.4	13.7	10.9	8.2	1.88	1.25	0.94	0.75	
	60	5.3	45.2	36.2	30.2	22.6	18.1	15.1	12.1	9.0	2.08	1.38	1.04	0.83	
80 (1/2")	30	6.9	68.3	54.6	45.5	34.2	27.3	22.8	18.2	13.7	3.14	2.09	1.57	1.25	13
	40	8.0	79.2	63.4	52.8	39.6	31.7	26.4	21.1	15.8	3.64	2.42	1.82	1.45	
	50	8.9	88.1	70.5	58.7	44.1	35.2	29.4	23.5	17.6	4.04	2.70	2.02	1.62	
	60	9.8	97.0	77.6	64.7	48.5	38.8	32.3	25.9	19.4	4.45	2.97	2.23	1.78	
167 (3/4")	30	14.5	128	103	85.4	64.1	51.3	42.7	34.2	25.6	5.88	3.92	2.94	2.35	15
	40	16.7	148	118	98.4	73.8	59.0	49.2	39.4	29.5	6.78	4.52	3.39	2.71	
	50	18.7	165	132	110	82.6	66.1	55.1	44.1	33.1	7.59	5.06	3.79	3.03	
	60	20.5	181	145	121	90.6	72.5	60.4	48.3	36.2	8.32	5.54	4.16	3.33	
215 (3/4")	30	18.6	144	115	95.9	71.9	57.5	48.0	38.4	28.8	6.60	4.40	3.30	2.64	16
	40	21.5	166	133	111	83.1	66.5	55.4	44.3	33.3	7.63	5.09	3.82	3.05	
	50	24.0	186	149	124	92.8	74.3	61.9	49.5	37.1	8.52	5.68	4.26	3.41	
	60	26.3	203	163	136	102	81.4	67.8	54.2	40.7	9.34	6.22	4.67	3.73	

Typical Spray Pattern Produced by XT Series

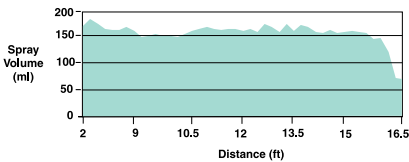

Common Uses of the Boom X Tender Spray Nozzles

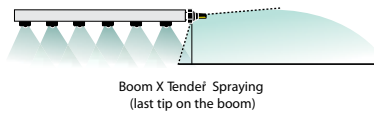

Adjustable Swath Width

Swath width can be increased or decreased by adjusting the angle of the tip/± 18°.

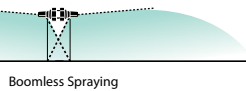
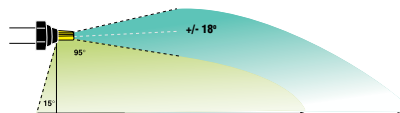

Boomless Spraying with Center Nozzle



WETBOOM STYLE BOOMLESS NOZZLES

FEATURES:

- Easily Convert Handgun Sprayer To A Broadcast Sprayer (3 GPM Minimum)
- Nozzle Assemblies Fit 5100316 Stainless Steel Tube
- Center Nozzle Assembly Inlet 1/2" Hose
- Shut-Off Valves Built Into Nozzle Assembly
- 30 Foot Total Swath
- Nozzle Assemblies Have Built In Swivel

Part #	Description
5275122	Polyacetal Left/Right Nozzle Assembly, 13' Coverage
5275123	Polyacetal Center Nozzle Assembly, 4' Coverage
5100316	Stainless Steel Tube
5274861	X Tender Tip, Yellow



EXTEND YOUR SPRAYING POSSIBILITIES!

Left & Right Nozzles



Center Nozzle



Part #	Description
5274751	Polyacetal Left Nozzle Assembly, 13' Coverage
5274752	Polyacetal Center Nozzle Assembly, 4' Coverage
5274861	X Tender Tip, Yellow

FEATURES:

- Easily Convert Handgun Sprayer To A Broadcast Sprayer (3 GPM Min)
- Nozzle Assemblies Fit 1/2" Hose
- Shut-Off Valves Built Into Nozzle Assem.
- 30 Foot Total Swath
- Nozzle Assemblies Have Built In Swivel So That Spray Can Be Targeted To Application Zone

BOOM BUSTER BOOMLESS NOZZLES

Part #	Thread Size	Effective Distance
BB120-5	1/4" MNPT	5 FT
BB120-5R	1/4" MNPT	5 FT ROADSIDE
BB125	1/4" MNPT	17 FT
BB125-R	1/4" MNPT	17 FT ROADSIDE
BB140	1/4" MNPT	18 FT
BB140-R	1/4" MNPT	18 FT ROADSIDE
BB180-10	3/8" MNPT	10 FT
BB180-10R	3/8" MNPT	10 FT ROADSIDE
BB187	3/8" MNPT	20 FT
BB187-R	3/8" MNPT	20 FT ROADSIDE
BB260-11	1/2" MNPT	11 FT
BB260-11R	1/2" MNPT	11 FT ROADSIDE
BB265	1/2" MNPT	21 FT
BB265-R	1/2" MNPT	21 FT ROADSIDE
BB375	3/4" MNPT	23 FT
BB375-R	3/4" MNPT	23 FT ROADSIDE
BB437	3/4" MNPT	31 FT
BB437-R	3/4" MNPT	31 FT ROADSIDE



- The nozzles shown with an "R" designation is for right of way spraying. For two nozzles mounted back to back, use standard numbers (less R) to insure center overlap.
- Effective distance shown based on 36" mounting height above target application zone.



Agricultural Application Chart. Find the Boom Buster Nozzle that is just right for your application needs.

		Gallons Per Acre (each nozzle)																
Model	PSI	Range (feet)	Nozzle angle	1	2	3	4	5	6	7	8	9	10	11	12	13	14	15
125 1/4" Pipe Thread	30	1.7	LEVEL	54	27	18	14	11	9	8	7	6	5					
	40	2	DOWN	64	32	21	16	13	11	9	8	7	6					
120-3 1/4" Pipe Thread	30	1.7	DOWN	281	140	94	70	55	47	40	35	31	28	26	23	22	20	19
	40	2	DOWN	330	165	110	81	65	55	47	41	37	33	30	28	25	24	22
120-5 1/4" Pipe Thread	30	1.7	DOWN	363	182	123	91	71	61	53	45	40	36	33	30	28	26	24
	40	2	DOWN	408	204	136	101	78	64	54	46	40	36	33	30	28	26	24
140 1/4" Pipe Thread	30	2	LEVEL	60	30	20	15	12	10	9	8	7	6	5.5	5.0	4.0	4.3	6.4
	40	2.4	DOWN	70	35	24	18	14	11	10	9	8	7	6.5	6.0	5.0	5.0	7.7
180-6 1/2" Pipe Thread	30	2.7	DOWN	81	41	27	20	15	12	10	9	8	7	6.4	6.0	5.0	5.0	8.0
	40	3.3	DOWN	297	149	98	74	59	49	41	35	30	27	25	23	21	20	20
180-10 1/2" Pipe Thread	30	3.6	DOWN	305	153	101	76	59	49	41	35	30	27	25	23	21	20	20
	40	4.3	DOWN	355	177	118	89	71	59	51	44	39	35	32	30	27	25	24
187 1/2" Pipe Thread	30	3.5	LEVEL	396	198	132	97	76	66	57	50	44	40	36	33	30	28	26
	40	4.3	DOWN	458	229	152	112	88	73	63	55	48	43	40	36	33	30	28
260-5 1/2" Pipe Thread	30	6.8	DOWN	179	89	59	45	36	30	25	22	20	18	16	15	14	13	12
	40	8	DOWN	213	106	71	53	41	35	30	27	24	21	19	17	15	14	13
260-11 1/2" Pipe Thread	30	6.8	DOWN	738	369	246	184	141	117	100	87	77	69	63	58	53	49	46
	40	8	DOWN	871	436	290	218	174	145	124	109	97	87	79	73	67	62	58
265 1/2" Pipe Thread	30	6.8	DOWN	360	180	120	90	71	60	51	45	40	36	33	30	28	26	24
	40	8	DOWN	390	195	130	97	78	66	57	50	44	40	36	33	30	28	26
370 3/4" Pipe Thread	30	6.8	DOWN	173	86	56	43	35	29	25	22	19	17	16	14	13	12	11
	40	8	DOWN	203	102	68	51	41	34	29	25	23	20	18	17	15	14	13
375 3/4" Pipe Thread	30	14.4	LEVEL	223	112	74	56	43	37	32	28	25	22	20	19	17	16	15
	40	16.7	DOWN	713	356	238	178	141	119	102	89	79	71	65	60	55	51	48
437 3/4" Pipe Thread	30	14.4	LEVEL	877	438	291	207	165	138	119	104	92	83	75	69	64	59	56
	40	16.7	DOWN	931	465	310	224	180	155	134	119	105	93	85	78	72	68	63
500 1" Pipe Thread	30	14.4	LEVEL	352	176	117	87	68	55	47	41	37	33	30	28	26	24	22
	40	16.7	DOWN	384	192	128	96	77	64	55	48	43	38	35	32	30	27	26
504 1" Pipe Thread	30	18.5	UP	433	216	144	108	87	72	62	54	48	43	39	36	33	31	29
	40	21.5	UP	310	155	103	78	61	52	44	39	34	31	28	26	24	22	21
504 1" Pipe Thread	30	29	LEVEL	361	180	120	90	71	60	51	45	40	36	33	30	28	26	24
	40	33	DOWN	406	203	135	102	81	68	58	51	45	41	37	34	31	29	27
504 1" Pipe Thread	30	29	LEVEL	718	359	239	179	144	120	103	90	80	72	66	60	55	51	48
	40	33	DOWN	817	408	272	204	163	136	117	102	91	81	74	68	63	58	54
504 1" Pipe Thread	30	29	UP	910	456	305	224	183	153	133	124	102	92	83	76	70	65	61
	40	33	UP	359	179	120	90	72	60	51	45	40	36	33	30	28	26	24
504 1" Pipe Thread	30	29	UP	408	204	136	102	81	68	58	51	45	41	37	34	31	29	27
	40	33	UP	458	229	153	114	92	76	65	57	51	46	42	38	35	33	31

50 to 100 gallons per acre
 less than 20 gallons per acre
 100+ gallons per acre
 20 to 50 gallons per acre

PSI - Pounds Per Square Inch
GPM - Gallons Per Minute

HAMILTON BOOMLESS NOZZLES



OPERATING DATA FOR 180° NOZZLES

Orifice No.	PSI	GPM 180°	SWATH 180°	GALLONS PER ACRE				
				3MPH	4MPH	5MPH	8MPH	10MPH
1/4" #2 6560-01 FNPT	30	.85	22'	3.2	2.4	1.9	1.2	.95
	40	1.0	23'	3.6	2.7	2.15	1.35	1.1
	50	1.1	24'	3.8	2.85	2.25	1.45	1.15
6570-01 MNPT	60	1.2	25'	3.95	2.95	2.4	1.5	1.2
	30	1.7	44'	6.4	4.8	3.8	2.4	1.9
1/4" #5 6561-01 FNPT	40	2.0	46'	7.2	5.4	4.3	2.7	2.2
	50	2.2	48'	7.6	5.7	4.5	2.9	2.3
	60	2.4	50'	7.9	5.9	4.8	3.0	2.4
1/4" #10 6562-01 FNPT	30	3.7	50'	12.0	9.2	7.3	4.6	3.7
	40	4.2	50'	13.9	10.4	8.3	5.2	4.2
	50	4.6	52'	14.6	10.9	8.8	5.5	4.4
	60	5.0	52'	15.8	11.9	9.5	5.9	4.8
1/4" #20 6563-01 FNPT	30	5.1	54'	15.6	11.6	9.3	5.8	4.7
	40	5.9	54'	18.0	13.5	10.8	6.8	5.4
	50	6.7	56'	19.7	14.8	11.8	7.4	5.9
	60	7.1	58'	20.2	15.1	12.1	7.6	6.1

NOTE: 90° nozzles have the same GPA but 1/2 GPM and swath



Part #	MFG#	Description
654001	6540-01	Hamilton 6540-01 #5 Boomless Nozzle 180°
654101	6541-01	Hamilton 6540-01 #10 Boomless Nozzle 180°
654201	6542-01	Hamilton 6540-01 #20 Boomless Nozzle 180°

CALIBRATING YOUR SPRAYER

To determine pressure & GPA with a boomless nozzle use this calibration for it is different than a boom calibration:

$$\text{GPA} = \frac{495 \times \text{GPM}}{\text{MPH} \times \text{Swath in feet}}$$

EXAMPLE: $\frac{495(\text{constant}) \times 4.2\text{gpm}}{4\text{mph} \times 50'\text{swath}} = 2079$

$$\frac{2079}{200} = 10.395 \text{ GPA}$$



BOOMINATOR®

SPRAY NOZZLES

Part #	Description
1165L	Boominator LH 1.4 GPM@40PSI-5' sh-pat
1165R	Boominator RH 1.4 GPM@40PSI-5' sh-pat
1160L	Boominator LH 1.4GPM@40PSI-16' reg-pat
1160R	Boominator RH 1.4GPM@40PSI-16' reg-pat
1255L	Boominator LH 2GPM@40PSI-5' sh-pat
1255R	Boominator RH 2GPM@40PSI-5' sh-pat
1250L	Boominator LH 2GPM@40PSI-16' reg-pat
1250R	Boominator RH 2GPM@40PSI-16' reg-pat
1871L	Boominator LH 4.3GPM@40PSI-10' sh-pat
1871R	Boominator RH 4.3GPM@40PSI-10' sh-pat
1870L	Boominator LH 4.3GPM@40PSI-18' reg-pat
1870R	Boominator RH 4.3GPM@40PSI-18' reg-pat
2650L	Boominator LH 8.5GPM@40PSI-20' reg-pat
2650R	Boominator RH 8.5GPM@40PSI-20' reg-pat
1400FS	Boominator 2.5GPM@40PSI-17' full-pat
1870FS	Boominator 4.3GPM@40PSI-18' full pat
1870FL	Boominator 4.3GPM@40PSI-30' full pat
1200PS	Boominator poly 1.4GPM@40PSI-14' full-pat
1400PS	Boominator poly 2.5GPM@40PSI-14' full pat
1400PL	Boominator poly 2.8GPM@40PSI-20' full pat
1400PSR	Boominator RH poly 2.5GPM@40PSI-13' reg-pat



		1/4" MNPT		SPEED (MPH)						
PSI	GPM	SPRAY PATTERN	1	2	3	4	5	6	7	
1250 Right or Left	20	1.5 16 ft	46	23	16	12	9	8	7	
	30	1.7 16 ft	53	26	18	13	11	9	8	
	40	2.0 16 ft	62	31	21	15	12	10	9	

		1/4" MNPT		SPEED (MPH)											
PSI	GPM	SPRAY PATTERN	2	3	4	5	6	7	8	9	10	11	12		
1870 Right or Left	20	3.0 18 ft	41	28	21	17	14	12	10	9	8	7.5	7		
	30	3.5 18 ft	48	32	24	19	16	14	12	11	10	9	8		
	40	4.3 18 ft	59	39	30	24	20	17	15	13	12	11	10		

		1/2" MNPT		SPEED (MPH)														
PSI	GPM	SPRAY PATTERN	2	3	4	5	6	7	8	9	10	11	12	13	14	15		
2650 Right or Left	20	6.7 20 ft	83	55	41	33	28	24	21	18	16	15	14	13	12	11		
	30	7.5 20 ft	93	62	46	37	32	28	23	20	18	17	16	14	13	12		
	40	8.5 20 ft	105	70	51	42	36	30	26	23	21	19	17	16	15	14		

1200 PS - ECO SERIES FULL SPRAY									
(1/4" MNPT)			SPEED (MPH)						
PSI	GPM	SPRAY PATTERN	1	2	3	4	5	6	7
			GALLONS PER ACRE						
20	1.0	14 FT	35	18	12	9	7	6	5
30	1.2	14 FT	42	21	14	10	8	7	6
40	1.4	14 FT	49.5	25	16.5	12	10	8	7

1870 PL - FULL PATTERN													
(1/4" MNPT)			SPEED (MPH)										
PSI	GPM	SPRAY PATTERN	2	3	4	5	6	7	8	9	10	11	12
			GALLONS PER ACRE										
20	3.0	30 FT	25	17	12	10	8	7	6	5.5	5	4.5	4
30	3.5	30 FT	29	19	14	12	10	8	7	6	5.5	5	4.5
40	4.3	30 FT	36	25	18	14	12	10	9	8	7	6.5	6

1870 RIGHT OR LEFT - STANDARD PATTERN													
(1/4" MNPT)			SPEED (MPH)										
PSI	GPM	SPRAY PATTERN	2	3	4	5	6	7	8	9	10	11	12
			GALLONS PER ACRE										
20	3.0	18 FT	41	28	21	17	14	12	10	9	8	7.5	7
30	3.5	18 FT	48	32	24	19	16	14	12	11	10	9	8
40	4.3	18 FT	59	39	30	24	20	17	15	13	12	11	10



BoomJet®

Part #
5880-3/4-2TOC*



Boomless Nozzles with Extra-Wide Flat Spray Projection



Type 5880 BoomJet nozzle is used for spraying areas not easily accessed with a boom sprayer. It combines two off-center tips and three VeeJet® nozzles to produce an overall wide swath flat spray. The nozzle assembly provides good distribution considering the wide pattern coverage obtained; however, the uniformity is not as good as with a properly operated boom sprayer.* Supplied with one additional 1/4 NPT pipe plug and one blank tip for setting BoomJet to one side only. Also has a 1/4 pressure gauge port.

*Uniformity can be optimized by double overlapping spray swaths on successive sprayer passes. Remember, this also doubles the application volume.

How to order:

Specify BoomJet nozzle number.
Example: 5880-3/4-2TOC-06



W = Maximum effective coverage with nozzle mounted at 36" height.

Image	Image (2)	Image (2)	Image (1)	PSI	GPM	"W" (FEET)	GPA					GALLONS PER 1000 SQ. FT.			
							4 MPH	5 MPH	7.5 MPH	10 MPH	15 MPH	2 MPH	3 MPH	4 MPH	5 MPH
5880-3/4-2TOC06	6733-OC06	H1/4VV-1506	H1/4VVL-9502 with 50 mesh strainer	20	1.84	33.5	6.8	5.4	3.6	2.7	1.8	0.31	0.21	0.16	0.12
				30	2.25	34	8.2	6.6	4.4	3.3	2.2	0.38	0.25	0.19	0.15
				40	2.60	34.5	9.3	7.5	5.0	3.7	2.5	0.43	0.28	0.21	0.17
5880-3/4-2TOC10	OC10	H1/4U-0508HE	H1/4VVL-11004 with 50 mesh strainer	20	2.83	39.5	8.9	7.1	4.7	3.5	2.4	0.41	0.27	0.20	0.16
				30	3.46	40	10.7	8.6	5.7	4.3	2.9	0.49	0.33	0.25	0.20
				40	4.00	40.5	12.2	9.8	6.5	4.9	3.3	0.56	0.37	0.28	0.22
5880-3/4-2TOC20	OC20	H1/4U-0520HE	H1/4VVL-9506 with 50 mesh strainer	20	6.08	47	16.0	12.8	8.5	6.4	4.3	0.73	0.49	0.37	0.29
				30	7.45	50	18.4	14.8	9.8	7.4	4.9	0.84	0.56	0.42	0.34
				40	8.60	52	20	16.4	10.9	8.2	5.5	0.94	0.62	0.47	0.37
5880-3/4-2TOC40	OC40	H1/4U-0540HE	H1/4U-9510	20	12.0	56	27	21	14.1	10.6	7.1	1.2	0.81	0.61	0.49
				30	14.7	60	30	24	16.2	12.1	8.1	1.4	0.93	0.69	0.56
				40	17.0	63	33	27	17.8	13.4	8.9	1.5	1.0	0.76	0.61

Note: Always double check your application rates. Tabulations are based on spraying water at 70°F (21°C). See pages 281-293 for useful formulas and information.

FieldJet®

Part # Description
1/4KLC-* Brass
1/4KLC-SS* Stainless

Boomless Nozzles with Extra-Wide Flat Spray Projection

The KLC FieldJet nozzle is typically used to spray areas not accessible with a boom sprayer. Its one-piece nozzle design projects spray to both sides to form a wide swath flat spray. The round orifice minimizes clogging. Uniformity across the swath is not as good as with a properly operated boom sprayer.* Available in brass or stainless steel.

*Uniformity can be optimized by double overlapping spray swaths on successive sprayer passes. Remember, this also doubles the application volume.



Type 1/4-KLC and Type 3/4-KLC
1/4" NPT male and 3/4" NPT male pipe connections

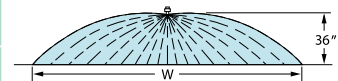

How to order:
Specify part number and material.
Example: 1/4KLC-SS18 - Stainless Steel

Image	PIPE CONNECTION	PSI	CAPACITY ONE NOZZLE IN GPM	"W" IN FEET	GPA				GALLONS PER 1000 SQ. FT.			
					3 MPH	4 MPH	5 MPH	8 MPH	3 MPH	4 MPH	5 MPH	8 MPH
1/4KLC-5	1/4"	20	0.71	17	6.9	5.2	4.1	2.6	.16	.12	.09	.06
		30	0.87	18	8.0	6.0	4.8	3.0	.18	.14	.11	.07
		40	1.00	21	7.9	5.9	4.7	2.9	.18	.13	.11	.07
1/4KLC-9	1/4"	20	1.27	18	11.6	8.7	7.0	4.4	.27	.20	.16	.10
		30	1.56	19	13.5	10.2	8.1	5.1	.31	.23	.19	.12
		40	1.80	21	14.1	10.6	8.5	5.3	.32	.24	.19	.12
1/4KLC-18	1/4"	20	2.55	20	21	15.8	12.6	7.9	.48	.36	.29	.18
		30	3.12	21	25	18.4	14.7	9.2	.56	.42	.34	.21
		40	3.60	22	27	20	16.2	10.1	.62	.46	.37	.23
1/4KLC-36	1/4"	20	5.09	22	38	29	23	14.3	.87	.66	.52	.33
		30	6.24	24	43	32	26	16.1	.98	.74	.59	.37
		40	7.20	26	46	34	27	17.1	1.0	.78	.63	.39
3/4KLC-50	3/4"	20	7.07	23	51	38	30	19.0	1.2	.87	.70	.44
		30	8.66	26	55	41	33	21	1.3	.94	.75	.47
		40	10.0	28	59	44	35	22	1.3	1.0	.81	.51
3/4KLC-72	3/4"	20	10.2	25	67	50	40	25	1.5	1.2	.92	.58
		30	12.5	29	71	53	43	27	1.6	1.2	.98	.61
		40	14.4	31	77	57	46	29	1.8	1.3	1.1	.66
3/4KLC-108	3/4"	20	15.3	28	90	68	54	34	2.1	1.5	1.2	.77
		30	18.7	33	94	70	56	35	2.1	1.6	1.3	.80
		40	21.6	36	99	74	59	37	2.3	1.7	1.4	.85

Note: Always double check your application rates. Tabulations are based on spraying water at 70°F (21°C). See pages 281-293 for useful formulas and information.

SPRAY TIPS & NOZZLES



Type	Size	Orifice Insert/ Tip Body Material	Part #
XR TeeJet Extended Range Tips (Tapered Flat Spray)	-01 and larger	Polymer (110° Only)	XR11002-VP
	-01 and larger	Ceramic (110° Only)	XR11003-VK



Type	Size	Orifice Insert/ Tip Body Material	Part #
DG TeeJet Drift Guard Tips (Tapered Flat Spray)	-01 thru -05	Polymer pre-Orifice	DG11002-VP



Type	Size	Orifice Insert/ Tip Body Material	Part #
TeeJet Spray Tips (Tapered Flat Spray)	-0050 or smaller	Brass	TP800050
	Larger than -0050	Brass	TP800067
	Smaller than -01	Stainless Steel	TP800067-SS
	-01 and larger	Stainless Steel	TP11001-SS
		Hard. Stainless Steel	TP11001-HSS



Type	Size	Orifice Insert/ Tip Body Material	Part #
TeeJet Spray Tips (Tapered Flat Spray)	015 and larger	Polymer	TP8002VP



Type	Size	Orifice Insert/ Tip Body Material	Part #
TeeJet Spray Tips (Even Flat Spray)	-01 and larger	Brass	TP8001E
	-01 and larger	Stainless Steel	TP8001E-SS



Type	Size	Orifice Insert/ Tip Body Material	Part #
TurfJet Spray Tips (Wide Angle Flat Spray)	-02 Thru -15	Stainless Steel/Celcon With Polymer Pre-Orifice	1/4TTJ05-VS
	-02 Thru -15	Polymer	1/4TTJ06-VP

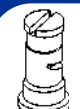

Type	Size	Orifice Insert/ Tip Body Material	Part #
FloodJet Spray Tips (Wide Angle Flat Spray)	All Sizes	Polymer	TF-VP4

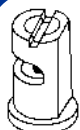

Type	Size	Orifice Insert/ Tip Body Material	Part #
FloodJet Spray Tips (Wide Angle Flat Spray)	All Sizes	Brass	TK-3
		Stainless Steel	TK-SS3
		Stainless Steel/Celcon	TK-VS3

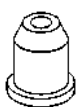

Type	Size	Orifice Insert/ Tip Body Material	Part #
TG FullJet Spray Tips (Full Cone Spray)	Smaller than 1	Brass	TG-0.9
		Stainless Steel	TG-SS0.9
		Stainless Steel	TG-SS1



Type	Size	Orifice Insert/ Tip Body Material	Part #
TX ConeJet Spray Tips (Hollow Cone Spray)	All Sizes	Brass	TX-1
		Ceramic	TX-VK3

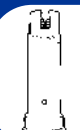

Type	Size	Orifice Insert/ Tip Body Material	Part #
AI TeeJet UB-Underleaf Banding Spray Tips	All Sizes	Stainless Steel/Celcon (85° Only)	AIUB8504VS

SPRAY TIPS & NOZZLES



FLOODJET NOZZLES



Part #	Description
1/8K-*	1/8" MPT Brass Floodjet Nozzle
3/8K-*	3/8" MPT Brass Floodjet Nozzle
1/2K-*	1/2" MPT Brass Floodjet Nozzle
3/4K-90 to 120	3/4" MPT Brass Floodjet Nozzle
1K-300	1" MPT Brass Floodjet Nozzle
1K-450	1" MPT Brass Floodjet Nozzle
1/8K-SS*	1/8" MPT Stainless Steel Floodjet Nozzle
1/4K-SS*	1/4" MPT Stainless Steel Floodjet Nozzle
3/8K-SS*	3/8" MPT Stainless Steel Floodjet Nozzle
1/2K-SS*	1/2" MPT Stainless Steel Floodjet Nozzle
3/4K-SS80 to 120	3/4" MPT Stainless Steel Floodjet Nozzle
3/4K-SS140 to 210	3/4" MPT Stainless Steel Floodjet Nozzle
1K-SS300	1" MPT Stainless Steel Floodjet Nozzle

QUICK TURBO FLOODJET NOZZLES



Part #	Description
QCTF-VS15 to 80	Stainless Steel QuickTurbo FloodJet Nozzle
QCTF-VS100 to 120	Stainless Steel QuickTurbo FloodJet Nozzle

QUICK FLOODJET NOZZLES



Part #	Description
QCK-SS20 to 40	Stainless Steel Quick Floodjet Nozzle
QCK-SS50 to 80	Stainless Steel Quick Floodjet Nozzle
QCK-SS100 and 120	Stainless Steel Quick Floodjet Nozzle
QCK-SS150 to 210	Stainless Steel Quick Floodjet Nozzle

FIELDJET NOZZLES



Part #	Description
1/4KLC-*	1/4" MPT Brass Fieldjet Nozzle
1/4KLC-SS*	1/4" MPT Stainless Steel Fieldjet Nozzle
3/4KLC-*	3/4" MPT Brass Fieldjet Nozzle
3/4KLC-SS*	3/4" MPT Stainless Steel Fieldjet Nozzle

BOOMJET AND OFF-CENTER NOZZLES



DDOC Doclet

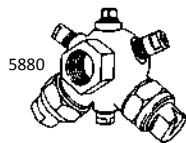

DOC DocJet

Part #	Description
4418-3/4-2TOC*	Brass Boomjet Nozzle
4629-3/4-TOC*	Brass Boomjet Nozzle
5430-3/4-2TOC*	Brass Boomjet Nozzle
5880-3/4-2TOC*	Brass Boomjet Nozzle
DOC-*	Brass Docjet Tip Nozzle
DDOC-*	Brass Docjet Tip Nozzle
CP7627-R	Rubber Selector Plug for DDOC

STREAMJET NOZZLES



Part #	Description
H1/4U-SS*	Stainless Steel, Solid Stream Spray

WHIRLJET NOZZLES



Part #	Description
1/4B-SS*-*W	Stainless Steel Whirljet Nozzle

FLOW REGULATORS



Part #	Description
CP4928-SS	Stainless Steel Adapter
CP4916-*	Stainless Steel Orifice Plate

TEEJET STRAINER ASSEMBLIES

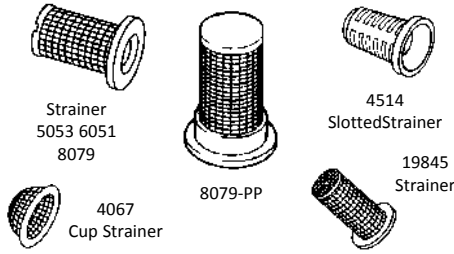

Part #	Description
19845-* PP	All Polypropylene (25 and 50 mesh)
5053-* SS	Brass With SS Screen (24, 50, 80, 100, 200 mesh)
6051- SS -*	Stainless Steel Throughout (24, 50, 80, 100, 110, 200 mesh)
8079- PP -*	Polypropylene With SS Screen (24, 80, 200 mesh)
5054-* SS	Extra-long, Brass With SS Screen (50, 100 mesh)
4514-*	Slotted Strainer, Brass (10, 20, 32, 40 mesh)
4514- NY -*	Nylon Slotted Strainer (10, 20, 32 mesh)
4067- SS -*	Cup Strainer, Stainless Steel

*Mesh Size

TEEJET CHECK VALVES

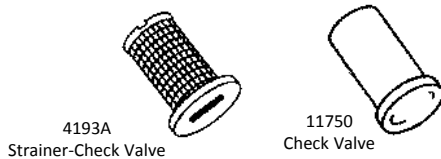

Part #	Description
4193A-#-* SS	Brass/SS Screen (24, 50, 80, 100, 110, 200 mesh)
4193A- PP -#-* SS	Polypropylene With SS & Viton Ball (24, 50, 80, 100, 200 mesh)
4193A- SS -#-* SS	Stainless Steel Throughout (24, 50, 100, 200 mesh)
11750-*	Brass (5 or 10 lb)
11750- SS -*	Stainless Steel (5 or 10 lb)
11750- PP -*	Polypropylene (5 or 10 lb)

*Mesh Size - #Check Valve Size

TEEJET PLUG TIPS



Part #	Description
CP3942	Brass Plug Tip
CP3942- AL	Aluminum Plug Tip
CP3942- SS	Stainless Steel Plug Tip
CP5539	Brass Blank Plug Tip For (3/4T)

HOSE DROPS

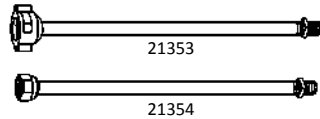

Part #	Description
21353-6-15- NYB	Quick TeeJet Hose Drop With EPDM Gasket 15"
21353-6-24- NYB	Quick TeeJet Hose Drop With EPDM Gasket 24"
21354-15- NYB	TeeJet Hose Drop, Nylon Throughout, 15"
21354-24- NYB	TeeJet Hose Drop, Nylon Throughout, 24"

SINGLE SWIVEL TEEJET NOZZLE BODY ASSEMBLIES



Part #	Description
5000	TeeJet Swivel Body Assembly, Brass
7620	TeeJet Swivel Body Assembly, Brass
8600	TeeJet Swivel Body Assembly, Nylon

DOUBLE SWIVEL TEEJET NOZZLE BODY ASSEMBLIES

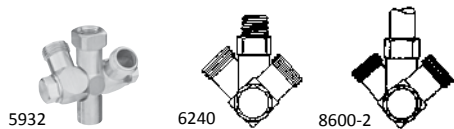

Part #	Description
6240-1/4 TT	TeeJet Swivel Body Assembly, Brass
5932-2-1/4 T	TeeJet Swivel Body Assembly, Brass
8600-2-1/4 T-NYB	TeeJet Swivel Body Assembly, Nylon

ROW APPLICATION KIT

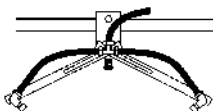

Part #	Description
23770- SS	Row Application Kit, Less Tips, Stainless Steel

VARI-SPACING TEEJET CLAMP ASSEMBLIES



Part #	Description
AA111-1/2,-3/4,-1	Clamp Sub-assembly - 1/2", 3/4", 1" Round
AA111-1-1/4	Clamp Sub-assembly - 1 1/4" Round
AA111SQ-1	Clamp Sub-assembly - 1" Square
AA111SQ-1-1/4	Clamp Sub-assembly - 1 1/4" Square
AA111SQ-1-1/2	Clamp Sub-assembly - 1 1/2" Square

VALVES & RINSING NOZZLES



PRESSURE RELIEF/REGULATING VALVES



6815

AA110

8460

23120A

Part #	Description
AA110-1/4-*	Brass 1/4" Pressure Relief Valve
AA110-3/8-*	Brass 3/8" Pressure Relief Valve
AA110-1	Brass 1" Pressure Relief Valve
AA110-1-DI	Ductile Iron 1" Pressure Relief Valve
AA110-1-AL	Aluminum 1" Pressure Relief Valve
AA110-1-1/4	Brass 1 1/4" Pressure Relief Valve
AA110-1-1/4-AL	Aluminum 1 1/4" Pressure Relief Valve
AA110-1-1/2	Brass 1 1/2" Pressure Relief Valve
AA110-1-1/2-DI	Ductile Iron 1 1/2" Pressure Relief Valve
6815-1/2 OR 3/4-*	Brass Pressure Relief Valve
8460-1/2-50	Nylon 1/2" Pressure Relief Valve
8460-3/4	Nylon 3/4" Pressure Relief Valve
23120-1/2-PP	Polypropylene 1/2" Pressure Relief Valve
23120-3/4-PP	Polypropylene 3/4" Pressure Relief Valve

* Specify PSI

DIRECTO VALVE MANUALLY OPERATED CONTROL VALVE

Part #	Description
AA6B	3/4" Female Inlet x 1/2" Female Outlet



TEEVALVE MANUAL CONTROL VALVE

Aluminum with 1" inlet connections

Part #	Inlet Size	(3) Boom Outlets	Accessory Outlet
AA17Y	1"	3/4"	3/4"
AA17L	3/4"	3/4"	3/4"



THROTTLING VALVE

Throttling valve,
polypropylene

Part #
23520-1/2-PP
23520-3/4-PP



SELF OPERATING SPRAY BALL

Includes:
2-5011164=3/4 x 4 poly Nipple
2-5270-3/4-18-POM

Part #	Description
RINSEBALL-KIT	Self Operating Spray Ball



CONTAINER RINSING NOZZLES

Part #	Description
VSM-1/2-*	28,44,90* CAPACITY
VSM-1/2-*	140,190* CAPACITY
VSM-3/4-90	



TANK RINSING NOZZLES

Part #	Description
55270-1/2-11-POM	1/2" Tank Rinsing Nozzle
55270-3/4-18-POM	3/4" Tank Rinsing Nozzle



HYPRO[®] PROCLEAN[™] NOZZLES & VALVE

HIGH PERFORMANCE TANK & CONTAINER WASH SPRAY NOZZLES

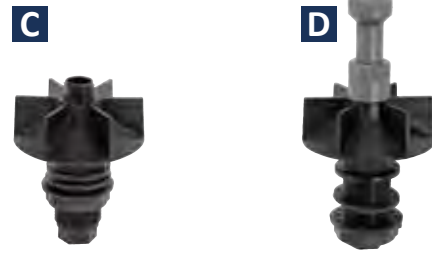

Part #	Photo Reference	Description
PC1/2F-36075	A	ProClean [™] Container Nozzle
PC1/2F-235120	B	ProClean [™] Tank Nozzle
3400-0174	C	ProClean [™] II Valve Assembly
BG-3400-0175	A & C	ProClean [™] II Valve and Nozzle
3400-0176	D	ProClean [™] II Valve Assembly With HF Nozzle

QUICK NOZZLE SYSTEMS FOR DRY BOOMS



QJ373-750-1-NYB



QJ373-750-2-NYB

Part #	Size	Description
QJ373-500-1-NYB	1/2"	Multi. Nozzle Body W/ Single Hose Shank
QJ373-500-2-NYB	1/2"	Multi. Nozzle Body W/ Double Hose Shank
QJ373-750-1-NYB	3/4"	Multi. Nozzle Body W/ Single Hose Shank
QJ373-750-2-NYB	3/4"	Multi. Nozzle Body W/ Double Hose Shank
QJ373-1000-1-NYB	1"	Multi. Nozzle Body W/ Single Hose Shank
QJ373-1000-2-NYB	1"	Multi. Nozzle Body W/ Double Hose Shank
QJ375-500-1-NYB	1/2"	Multi. Nozzle Body W/ Single Hose Shank
QJ375-500-2-NYB	1/2"	Multi. Nozzle Body W/ Double Hose Shank
QJ375-750-1-NYB	3/4"	Multi. Nozzle Body W/ Single Hose Shank
QJ375-750-2-NYB	3/4"	Multi. Nozzle Body W/ Double Hose Shank
QJ375-1000-1-NYB	1"	Multi. Nozzle Body W/ Single Hose Shank
QJ375-1000-2-NYB	1"	Multi. Nozzle Body W/ Double Hose Shank

HOSE SHANK DIAPHRAGM CHECK VALVES



19349



19350



19351

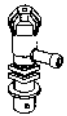

22251

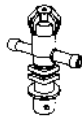

22252

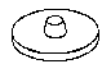

CP21953-EPR
OR
CP21953-VI



21950-8-NYB

Part #	Size	Description
19349-211-406-NYB	3/8"	Single Hose Shank Quick TeeJet Nozzle
19349-211-540-NYB	1/2"	Same As Above
19349-211-785-NYB	3/4"	Same As Above
19350-212-406-NYB	3/8"	Same As Above (Double Hose Shank)
19350-212-540-NYB	1/2"	Same As Above (Double Hose Shank)
19350-212-785-NYB	3/4"	Same As Above (Double Hose Shank)
19351-213-406-NYB	3/8"	Same As Above (Triple Hose Shank)
19351-213-540-NYB	1/2"	Same As Above (Triple Hose Shank)
19351-213-785-NYB	3/4"	Same As Above (Triple Hose Shank)
22251-311-375-NYB	3/8"	Same As Above (Single Hose Shank)
22251-311-500-NYB	1/2"	Same As Above (Single Hose Shank)
22251-311-750-NYB	3/4"	Same As Above (Single Hose Shank)
22252-312-375-NYB	3/8"	Same As Above (Double Hose Shank)
22252-312-500-NYB	1/2"	Same As Above (Double Hose Shank)
22252-312-750-NYB	3/4"	Same As Above (Double Hose Shank)
21950-2-NYB		2 lb. Chem-saver end cap
21950-5-NYB		5 lb. Chem-saver end cap
21950-8-NYB		8 lb. Chem-saver end cap
21950-10-NYB		10 lb. Chem-saver end cap
CP21953-EPR		EPDM diaphragm
CP21953-VI		VITON diaphragm

HOSE SHANK NOZZLE BODIES



18635

18638

18719

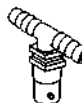

18636

18639

18720

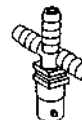

18637

18640

18721

Part #	Size	Description
18635-111-406-NYB	3/8"	Single Hose Shank Quick Nozzle Body
18638-111-540-NYB	1/2"	Single Hose Shank Quick Nozzle Body
18719-111-785-NYB	3/4"	Single Hose Shank Quick Nozzle Body
18636-112-406-NYB	3/8"	Double Hose Shank Quick Nozzle Body
18639-112-540-NYB	1/2"	Double Hose Shank Quick Nozzle Body
18720-112-785-NYB	3/4"	Double Hose Shank Quick Nozzle Body
18637-113-406-NYB	3/8"	Triple Hose Shank Quick Nozzle Body
18640-113-540-NYB	1/2"	Triple Hose Shank Quick Nozzle Body
18721-113-785-NYB	3/4"	Triple Hose Shank Quick Nozzle Body

VARI-SPACING CLAMPS



QJ111

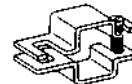

QJ111SQ

Part #	Description
QJ111-1/2,-3/4 or 1	1/2", 3/4" or 1" Vari-Spacing Quick Clamp Sub-assembly
QJ111-1-1/4	1 1/4" Vari-Spacing Quick Clamp Sub-assembly
QJ111SQ-3/4, or 1	3/4" or 1" Vari-Spacing Quick Clamp Sub-assembly
QJ111SQ-1-1/4	1 1/4" Vari-Spacing Quick Clamp Sub-assembly
QJ111SQ-1-1/2	1 1/2" Vari-Spacing Quick Clamp Sub-assembly
QJ111SQ-*3045S	3/4", 1", 1 1/4", or 1 1/2" SS Vari-Spacing Quick Clamp Sub-assembly

OTHER QUICK TEEJET CAPS FOR PRESSURES UP TO 300 PSI

Part #	Type	Description
QJ4676-1/8-NYR	Adapter Cap	Quick TeeJet Outlet Adapter with EPDM Seat Gasket, Black
QJ4676-1/4-NYR	Adapter Cap	Quick TeeJet Outlet Adapter with EPDM Seat Gasket, Black
19843-NYR	Shut-Off Cap	Quick TeeJet Shut-Off Cap and Seat Gasket Set
QJ4676-90-1/4-NYR	Adapter Cap	Quick TeeJet Outlet Adapter with EPDM Seat Gasket, Black, 90°
QJ4676-45-1/4-NYR	Adapter Cap	Quick TeeJet Outlet Adapter with EPDM Seat Gasket, Black, 45°

OTHER QUICK TEEJET GASKETS & SEALS



Part #	Description
CP19438-EPR	Quick TeeJet Seat Gasket, Standard EPDM Material (for use with all spray tips except Disc-Core type)
CP19438-VI	Quick TeeJet Seat Gasket, optional VITON Material
CP18999-EPR	Quick TeeJet Seal, EPDM, for Disc-Core type spray tips
CP18999-VI	Quick TeeJet Seal, optional VITON material



ADAPTERS

QJT



QJT8360

Part #	Size	Description
QJT-NYB		Quick TeeJet Adapter x 11/16" FPT
QJT8360-NYB		Diaphragm Check Valve Quick

NOZZLE BODIES

QUICK NOZZLE SYSTEMS FOR WET BOOMS



QJ373-1-NYB

QJ375-L-1-NYB

Part #	Size	Description
QJ373-1/2-NYB	1/2"	TRIPLE NOZZLE SPLIT EYELET DIAPHRAGM CHECK VALVE
QJ373-L-1/2-NYB	1/2"	TRIPLE NOZZLE SPLIT EYELET DIAPHRAGM CHECK VALVE
QJ373-3/4-NYB	3/4"	TRIPLE NOZZLE SPLIT EYELET DIAPHRAGM CHECK VALVE
QJ373-L-3/4-NYB	3/4"	TRIPLE NOZZLE SPLIT EYELET DIAPHRAGM CHECK VALVE
QJ373-1-NYB	1"	TRIPLE NOZZLE SPLIT EYELET DIAPHRAGM CHECK VALVE
QJ373-L-1-NYB	1"	TRIPLE NOZZLE SPLIT EYELET DIAPHRAGM CHECK VALVE
QJ375-1/2-NYB	1/2"	TRIPLE NOZZLE SPLIT EYELET DIAPHRAGM CHECK VALVE
QJ375-L-1/2-NYB	1/2"	TRIPLE NOZZLE SPLIT EYELET DIAPHRAGM CHECK VALVE
QJ375-3/4-NYB	3/4"	TRIPLE NOZZLE SPLIT EYELET DIAPHRAGM CHECK VALVE
QJ375-L-3/4-NYB	3/4"	TRIPLE NOZZLE SPLIT EYELET DIAPHRAGM CHECK VALVE
QJ375-1-NYB	1"	TRIPLE NOZZLE SPLIT EYELET DIAPHRAGM CHECK VALVE
QJ375-L-1-NYB	1"	TRIPLE NOZZLE SPLIT EYELET DIAPHRAGM CHECK VALVE

MULTIPLE NOZZLE BODIES FOR WET BOOMS



CP98488-VI
Retrofit Seal

Part #	Size	Description
QJ383-3/4-NYB	3/4"	Mult. Nozzle Split-Eyelet - 3 Spray Outlets
QJ383-1-NYB	1"	Mult. Nozzle Split-Eyelet - 3 Spray Outlets
CP98488-VI*	-	Hi-Flow Nozzle Body Adapter Insert
* Retrofit Seal - Adapts to any TeeJet QJ Wet Boom with 3/8" inlet to larger 11/16" (17mm) hole on Wet Boom.		

SPLIT-EYELET DIAPHRAGM CHECK VALVES

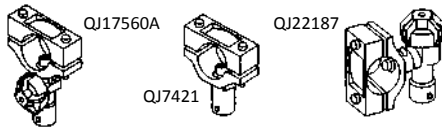

QJ17560A

QJ7421

QJ22187

Part #	Size	Description
QJ17560A-1/2-NYB	1/2"	Split-Eyelet Quick Diaphragm Check Valve
QJ17560A-3/4-NYB	3/4"	Split-Eyelet Quick Diaphragm Check Valve
QJ17560A-1-NYB	1"	Split-Eyelet Quick Diaphragm Check Valve
+QJ7421-1/2-NYB	1/2"	Split-Eyelet Quick TeeJet Nozzle Body
+QJ7421-3/4-NYB	3/4"	Split-Eyelet Quick TeeJet Nozzle Body
+QJ7421-1-NYB	1"	Split-Eyelet Quick TeeJet Nozzle Body
QJ22187-1/2-NYB	1/2"	Split-Eyelet Quick Diaphragm Check Valve
QJ22187-3/4-NYB	3/4"	Split-Eyelet Quick Diaphragm Check Valve
QJ22187-1-NYB	1"	Split-Eyelet Quick Diaphragm Check Valve
+ = Does Not Include Chemsaver		

TRIPLE NOZZLE BODIES WITH CHEMSAVER

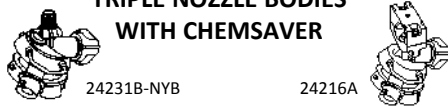

24231B-NYB

24216A

Part #	Size	Description
24231A-NYB		Diaphragm Check Valve Triple Nzl Bdy w/ 1/4" Inlet
24216A-1/2-NYB	1/2"	TeeJet Triple Nozzle Body
24216A-3/4-NYB	3/4"	TeeJet Triple Nozzle Body
24216A-1-NYB	1"	TeeJet Triple Nozzle Body

DIAPHRAGM CHECK VALVES

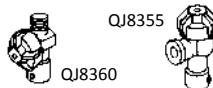

QJ8360

QJ8355

Part #	Size	Description
QJ8360-NYB	1/4" mpt	Diaphragm Check Valve Quick Nozzle Body
QJ8355-1/8-NYB	1/8" mpt	Diaphragm Check Valve Quick Nozzle Body
QJ8355-1/4-NYB	1/4" mpt	Diaphragm Check Valve Quick Nozzle Body

NOZZLE BODIES

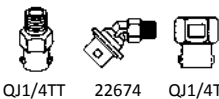

QJ1/4TT

22674

QJ1/4T

Part #	Size	Description
QJ1/4TT-NYB	1/4" mpt	Quick TeeJet Nozzle Body
QJ1/4T-NYB	1/4" fpt	Quick TeeJet Nozzle Body
22674-1/4-NYB	1/4" mpt	Quick TeeJet 45° Nozzle Body

SWIVELS

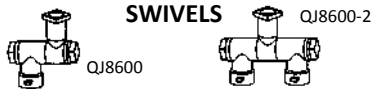

QJ8600

QJ8600-2

Part #	Size	Description
QJ8600-1/4-NYB	1/4" fpt	Single Swivel Quick TeeJet Nozzle Body
QJ8600-2-1/4-NYB	1/4" fpt	Double Swivel Quick TeeJet Nozzle Body

Diaphragm 2 lb. Check Valves

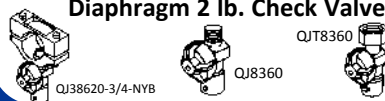

QJ38620-3/4-NYB

QJ8360

QJT8360

Part #	Size	Description
QJ38620-3/4-NYB	3/4"	Split-eyelet Quick 2 lb. Diaphragm Check Valve
QJ38621-NYB	1/4" mpt	2 lb. Diaphragm Check Valve
QJT83622-NYB	11/16" nzl	2 lb. Diaphragm Check Valve Body, 11/16" FPT

55295 E-CHEMSAVER ELECTRIC SOLENOID SHUTOFF

The 55295 e-ChemSaver is a solenoid actuated shutoff compatible with a wide range of TeeJet nozzle bodies equipped with a diaphragm check valve. It can be used for end of boom nozzles as well as individual tip shutoff and PWM controls.

Part #	Voltage	For Use With TeeJet Nozzle Body
55295-1-12	12	QJ8360, QJT8360, 8360, QJ17560A, QJP19011, QJ200 SERIES, QJ300 SERIES, QJ360E, QJ39685, 13431, 24216A, 24230A, 24231A
55295-1-12-05	12	e-ChemSaver, w/ 20" cable
55295-1-12-200	12	e-ChemSaver, w/ 65.6 Ft cable
98552-05		e-ChemSaver Cable w/ Metri-Pac Connection, 20"
98552-200	12	e-ChemSaver Cable w/ Metri-Pac Connection, 65.6 Ft



HYPRO® PROFLO NOZZLE BODIES



- Easy change of spray nozzles: 3-way or 5-way
- Provides lowest pressure drop at any given flow in the industry
- 2.6 gpm (9.84 LPM) with a 5 psi (.345 BAR) pressure drop
- Available in wet or dry boom versions

3 And 5-Way Nozzle Bodies For Wet Boom (No Tab For Boom Clamp)

EPDM Seals /RED Cap

Part #	Pipe Size	Turret #
4223N-B323-00	3/4"	3
4223N-B523-00	3/4"	5
4223N-B324-00	1"	3
4223N-B524-00*	1"	5

* EXPRESS BOOM replacement

VITON Seals /GREEN Cap

Part #	Pipe Size	Turret #
4223N-B323V-00	3/4"	3
4223N-B523V-00	3/4"	5
4223N-B324V-00	1"	3
4223N-B524V-00	1"	5

JUMBO HIGH VOLUME 5-WAY NOZZLE BODY

For Popular Self-Propelled Sprayers With 1" Booms With 11/16" (17 mm) Diameter Boom Holes

Designed as a direct replacement for popular self-propelled sprayers with 1" booms with 11/16" (17 mm) diameter boom holes. Easy fit connection for 1" pipe, includes stainless steel screw and nut. Standard with Viton® diaphragms. High volume - 6 GPM at 5 PSI pressure drop. Check valve closes at 12 PSI. 5-nozzle lugs fit TeeJet QuickJet 90° turn caps. Rated to 145 PSI.



Part #	Description
4072CLV01	Jumbo 5-Way Nozzle Body for 1" Boom
4072000.151	Replacement Viton® Diaphragm For Above
40720002.101	Replacement 12 PSI Check Valve For Above

QUICK NUT (QN) STAINLESS STEEL TUBE (SST) WET BOOM COMPONENTS



Part #	Description
25160-02	O-Ring FKM for 1" SST Fittings
25160-03	QN 1" SST Nut
25163-01	QN 1" SST Plug
25164-01	QN 1" SST X 3/4" FPT Adapter
25165-01	QN 1" SST Sight Bulb Plug-Clear
25166-01	QN Hose Shank—1" SST X 1" Hose Barb
25167-01	QN Hose Shank—1" SST X 1" Sweep 90 Barb
25168-00	QN Sweep Tee —1" Hose Barb X 1" SST X 1" SST
25170-00	QN Female Boom End Adapter Assembly—1.315" Tube X 1" SST
25171-00	QN Male Boom End Adapter—1.315" Tube X 1" SST
25172-00	QN Sweep Tee—1 1/4" Joint Adapter X 1" SST X 1" SST
25175-V0	QN SST Boom End Flush Valve (1 1/4" FNPT Compatible)
25176-V0	QN SST Boom End Flush Valve (1" FNPT Compatible)
5282418	1" SST Wet Boom Clamp Kit—1 1/2" Square Tube Mount
5282419	1" SST Wet Boom Clamp Kit—1 1/4" Square Tube Mount
5282420	1" SST Wet Boom Clamp Kit—1" Square Tube Mount
QJ373-1-NYB	373 Wet Boom for 1" Pipe—3-Way
QJ373-L-1-NYB	373 Wet Boom for 1" Pipe—3-Way (Left Side Diaphragm)
CP98583-3-1-SS	1" Pipe Rapid Stop Nozzle Body Adapter

HYPRO® EXPRESS WETBOOM



Performance Tested to 150 PSI Rating

- Available for the 6000/7000/8000 Series Pull-Type Sprayers
- Eliminates “dead-ends” of pipe where chemical residue can build-up
- Cleanout port for easy boom flushing
- Creates a cleaner looking plumbing system by eliminating the need for an extra fitting at the end of the boom
- Eliminates trapped air from the boom by allowing air to escape through the nozzle body, reducing nozzle turn-off time by 85%

Part #	Description
9315	3 Section x 15” Spacing Off Center
9515	5 Section x 15” Spacing Off Center
9320	3 Section x 20” Spacing Off Center
9520	5 Section x 20” Spacing Off Center

Kits available to fit most brands & models of sprayers

HYPRO® EXPRESS FLUSHING VALVE



Express End Cap
w/ Flush Valve
installed

Flush Valve for Express End Cap Retrofit

Part #	Description
BG-7433-3321	Express End Cap with Flush Valve installed
BG-7433-3319	Flush Valve for Express End Cap Retrofit

HYPRO® EXPRESS BOOM COMPONENTS



EXPRESS NOZZLE BODY END CAP

Part #	Description	Nozzle Body Type
BG-7433-3316	1" Express™ fitting with nozzle body end cap allows trapped air to escape through the nozzle body and includes removable plug for boom cleanout.	10 mm Stem



SERVICE KITS

Part #	Description
7433-2600	ProFlo Removable Plug with O-ring & Retainer Kit



EXPRESS UNIVERSAL FLANGE WET BOOM FITTINGS

Part #	Description	Reference
BG-7433-2502	Express Fitting X 1" Universal Flange Straight	1
BG-7433-2503	2 Express Fitting X 1" Universal Flange Tee (Vertical)	2
UFG0100E-A	1" EPDM Universal Flange Gasket	3
BG-UFC0100E	1" GTX Polymer Universal Flange Clamp w/Gasket	4
BG-UFC0100E-A-S	1" GTX Polymer Universal Flange Clamp With SS Fastener & Flange Gasket	5



EXPRESS HOSE BARB WET BOOM FITTINGS

Part #	Description	Reference
BG-7433-2608	Express Fitting X 1" Hose Barb Straight	1
BG-7433-2610	Express Fitting X 1" Hose Barb Elbow Vertical	2
BG-7433-2601	Express Fitting X 1" Hose Barb Elbow Horizontal	3



EXPRESS CAM LOCK WET BOOM FITTINGS

Part #	Description
BG-7433-2613	Express Fitting X 1" Male Cam Lock Straight



SERVICE KITS

Part #	Description	Reference
2910-0026	Clamp Assembly	1
1721-0225	O-Ring	2

BOOM COMPONENTS



HOSE SHANK & ADAPTERS

Part #	NPT Thread Conn. Male	For Hose I.D.	Material
8400-1/4-300-NYB	1/4"	1/4"	Nylon
8400-1/4-406-NYB	1/4"	3/8"	Nylon
8400-1/4-535-NYB	1/4"	1/2"	Nylon
8400-3/8-406-NYB	3/8"	3/8"	Nylon
8400-3/8-535-NYB	3/8"	1/2"	Nylon
8400-1/2-406-NYB	1/2"	3/8"	Nylon
8400-1/2-535-NYB	1/2"	1/2"	Nylon
8400-1/2-660-NYB	1/2"	5/8"	Nylon
8400-3/4-535-NYB	3/4"	1/2"	Nylon
8400-T-406-NYB	Fits	3/8"	Nylon

TeeJet Body with hose shank connection TeeJet Cap



Part #	NPT Thread Conn. Male	For Hose I.D.	Material
6053-400	1/4"	3/8"	Brass



Part #	NPT Thread Conn. Male	For Hose I.D.	Material
13435-406-NYB	1/4" (F)	3/8"	Nylon
13438-540-NYB	1/4" (F)	1/2"	Nylon



Part #	NPT Thread Conn. Male	For Hose I.D.	Material
13436-406-NYB	1/4" (F)	3/8"	Nylon
13439-540-NYB	1/4" (F)	1/2"	Nylon



Part #	NPT Thread Conn. Male	For Hose I.D.	Material
13434-406-NYB	1/4" (F)	3/8"	Nylon
13437-540-NYB	1/4" (F)	1/2"	Nylon



Part #	To Fit Hose I.D.	Material
15427-1-296	1/4"	Brass
12670-406TD-NYB	3/8"	Nylon



TEEJET HOSE SHANKS



Part #	Hose I.D.
8400-406-NYB	3/8"
8400-500-NYB	1/2"

TEEJET HOSE SHANKS



Part #	Hose I.D.
4251-250	1/4"
4251-312	5/16"
4251-400	3/8"
4251-500	1/2"

HOSE SHANK NOZZLE BODIES & NOZZLE CAPS

Part #	To Fit Hose I.D.	Material
6471B-400TD	3/8"	Brass
6471-SS-C400TD	3/8"	Stainless Steel
8121-NYB-406TD	3/8"	Nylon
8121-NYB-540TD	1/2"	Nylon
9191B-531TD	1/2"	Brass
9191-SS-C531TD	1/2"	Stainless Steel
12201-CE-785TD	3/4"	Celcon Hose Shank/Stainless Steel Threaded
12201-CE-1062TD	1"	Outlet



TEEJET SPLIT EYELET NOZZLE BODIES



Part #	Material	To Clamp On
7421-1/2T	Brass	1/2" Pipe
7421-1/2T-SS	SS	13/16" O.D. Tubing
7421-1/2T-NYB	Nylon	7/8" O.D. Tubing
7421-3/4T	Brass	3/4" Pipe
7421-3/4T-SS	SS	1" O.D. Tubing
7421-3/4T-NYB	Nylon	1 1/16" O.D. Tubing
7421-1T	Brass	1" Pipe
7421-1T-SS	SS	1 1/4" O.D. Tubing
7421-1T-NYB	Nylon	1 3/8" O.D. Tubing

Part #	To Fit Hose I.D.	Material
6472B-400TD	3/8"	Brass
6472-SS-C400TD	3/8"	Stainless Steel
8120-NYB-406TD	3/8"	Nylon
8120-NYB-540TD	1/2"	Nylon
9192B-531TD	1/2"	Brass
12202-CE-785TD	3/4"	Celcon Hose Shank/Stainless Steel Threaded
12202-CE-1062TD	1"	Outlet



TEEJET SPLIT EYELET NOZZLE BODIES



Part #	Material	To Clamp On
25775-1/2T-NYB	Nylon	1/2" T 13/16" O.D. Tubing 7/8" O.D. Tubing
25775-3/4T-NYB	Nylon	3/4" Pipe 1" O.D. Tubing 1 1/16" O.D. Tubing 1" Pipe
25775-1T-NYB	Nylon	1 1/4" O.D. Tubing 1 3/8" O.D. Tubing

TYPE-T NOZZLE BODIES

Female Inlet NPT or BSPT Connection

Part #	For TeeJet Nozzle Type	Male NPT Size	Material
CP1335	1/8T	1/8"	Brass
CP1321	1/4T	1/4"	Brass
CP12094-NYB	1/4T-NYB	1/4"	Nylon
CP1321	1/4T-SS	1/4"	Stainless Steel
CP1323	3/8T	3/8"	Brass
CP1339	1/2T	1/2"	Brass



TYPE-TT NOZZLE BODIES

Male Inlet NPT or BSPT Connection

Part #	For TeeJet Nozzle Type	Male NPT Size	Material
CP1336	1/8TT	1/8"	Brass
CP1322	1/4TT	1/4"	Brass
CP8028-NYB	1/4TT-NYB	1/4"	Nylon
CP1322-SS	1/4TT-SS	1/4"	Stainless Steel
CP1324	3/8TT	3/8"	Brass
CP1340	1/2TT	1/2"	Brass



TEEJET NOZZLE CAPS



Part #	Material
CP1325	Brass
CP8027-NYB	Nylon
CP8027-1-NYB	Nylon (Extra Long Size)
CP1325-AL	Aluminum
CP1325-SS	Winged Cap, Stainless Steel

TEEJET PLUG TIPS



Part #	Material
CP3942	Brass
CP3942-SS	Stainless Steel
CP5539	Blank Plug Tip for (3/4T) Brass

4676 TEEJET OUTLET ADAPTERS



Part #	Material	Outlet Conn. NPT (F)
4676-NYB.*	Nylon	1/8" or 1/4"
4676.*	Brass	1/8" or 1/4"
4676-SS.*	Stainless Steel	1/8" or 1/4"



POLYPROPYLENE BALL, SINGLE UNION & NOZZLE VALVES

- Glass reinforced polypropylene for strength and durability - will never rust or corrode
- Self-aligning ball rotates freely against Teflon seats
- Unique body-to-flange design allows for low torque on/off operation
- Viton O-ring stem seal
- EPDM O-ring body seal
- Pressure rated 125 PSI

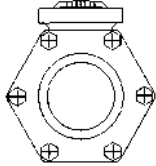

2" FP = full port
6 bolt
2" ball opening

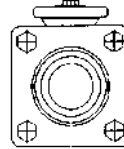

2" STD = standard port
4 bolt
1 1/2" ball opening

POLY BOLTED BALL VALVE STAINLESS STEEL BOLTS, NUTS & WASHERS

Part #	Size
NWV050FP	1/2"
NWV075FP	3/4"
NWV100STD	1"
NWV100FP	1"
NWV125STD	1 1/4"
NWV125FP	1 1/4"
NWV150FP	1 1/2"
NWV200STD	2"
NWV200FP	2"
NWV300FP	3"
NWV400FP	4"



ANGLE VALVE

Part #	Size
NWVA150FP	1 1/2"
NWVA200STD	2" std
NWVA200FP	2" fp

POLY BOLTED BALL VALVE WITH MALE NIPPLE

Part #	Size
NWVNIP200STD	2" std
NWVNIP200FP	2" fp
NWVNIP300FP	3" fp



SINGLE UNION BALL VALVE

Part #	Size
NWUV050	1/2"
NWUV075	3/4"
NWUV100	1"
NWUV125	1 1/4"
NWUV150	1 1/2"
NWUV200	2"
NWUV300	3"
NWUVA10045NZZL	1" nzl



NWUVA10045NZZL

MULTIPOINT BALL VALVE

Part #	Size
NWMP075	3/4"
NWMP200	2"



To see our wide variety of nurse trailer models: [Nurse Trailer Line Card \(pdf\)](#).

316 STAINLESS STEEL BALL VALVE

Part #	Size
SSV025	1/4"
200850M7606	3/8"
SSV050	1/2"
SSV075	3/4"
SSV100	1"
SSV150	1 1/2"
SSV200	2"
SSV300	3"



316 stainless with locking handle

- Manufactured from 316 SS
- Full port construction
- Water, oil and gas rated to 1000 PSI
- LOCKING HANDLE
- Teflon seats and seals
- Polished stainless steel ball for precise operation
- Tested by air pressure under water



COMPACT VALVES

SINGLE UNION VALVE REPAIR PARTS



Norwesco Single Union Repair Parts				
Size of SINGLE UNION VALVE	Repair kit EPDM O-rings Teflon Seat	Viton O-Rings	Handles	Valve Stem with EPDM O-Rings
1/2"	60430	60437	60444	60451
3/4"	60431	60438	60445	60452
1"	60432	60439	60446	60453
1 1/4"	60433	60440	60447	60454
1 1/2"	60434	60441	60448	60455
2"	60435	60442	60449	60456
3"	60436	60443	60450	60457
MULTI-PORT VALVE	Repair kit EPDM O-rings Teflon seat	T-Ball	Handles	Valve Stem with EPDM O-ring
3/4"	60438	60439	61736	60452

POLY COMPACT BALL VALVE STAINLESS STEEL BOLTS, NUTS & WASHERS



VALVE REPAIR PARTS

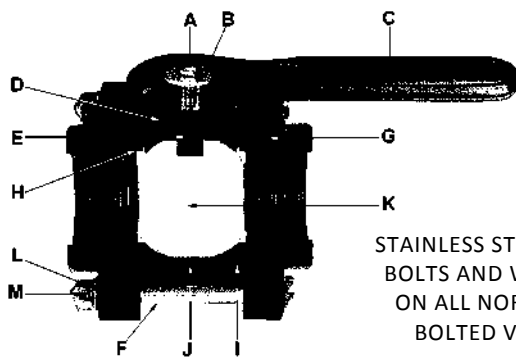

STAINLESS STEEL NUTS, BOLTS AND WASHERS ON ALL NORWESCO BOLTED VALVES

Part #	Size/Description
NWCV200MXF	2" fp / mpt x fpt
NWCV200FXF	2" fp / fpt x fpt
NWCV200MXM	2" fp / mpt x male coupler
NWCV200FXM	2" fp / fpt x male coupler

- Male pipe thread end flanges and cam action coupler end flange (F coupler) eliminate the need for additional fittings.
- Self-aligning ball rotates freely against Teflon seats.
- Viton O-ring stem seal and EPDM O-ring body seal.
- Pressure rated at 125 PSI @ 70°F.



POLY BOLTED VALVES



4 BOLT VALVES

- Stainless steel nuts & bolts
- 100% Teflon Ball Seats
- Viton Seals

Part #	Description	Opening Thru Ball
BJV050FP	Valve-Full Port	3/4"
BJV075FP	Valve-Full Port	3/4"
BJV100STD	Valve-Standard Port	3/4"
BJV100FP	Valve-Full Port	1"
BJV125STD	Valve-Standard Port	1"
BJV125FP	Valve-Full Port	1 1/2"
BJV150FP	Valve-Full Port	1 1/2"
BJV200STD	Valve-Standard Port	1 1/2"

4 BOLT VALVES



Part #	Description	Opening Thru Ball
BJVFMT204FP	2" Valve-Male NPT x Male Adapter-Full Port	2"
BJV204FP	2" Valve-Female NPT x Female NPT Full Port	2"

6 BOLT VALVES

- Stainless steel nuts & bolts
- 100% Teflon Ball Seats
- Viton Seals



Part #	Description	Opening Thru Ball
BJVFMT200FP	2" Male Adapter x 2" Male NPT Thread	2"



6 BOLT VALVES

- Stainless steel nuts & bolts
- 100% Teflon Ball Seats
- Viton Seals

Part #	Description	Opening Thru Ball
BJV200FP	Valve-Full Port	2 1/16"
BJV300STD	Valve-Standard Port	2 1/2"
BJV300FP	Valve-Full Port	3"
BJV400STD	Valve-Standard Port	4"

CASE QUANTITIES

V050FP thru V200STD	24/CASE
V200FP thru V300STD	8/CASE
V300FP	6/CASE
V400STD	4/CASE

HANDLE RISERS



Part #	Description	
V10153138BL	1" x 1 3/8" Handle Offset	3/4" & 1" 3-Way BL Valves
V10153138	1" x 1 3/8" Handle Offset	1" FP & 1 1/4" SP, 3/4" & 1" 3-Way SL Valves
V20153138BL	2" x 1 3/8" Handle Offset	1 1/4" & 1 1/2" 3-Way BL Valves
V20153138	2" x 1 3/8" Handle Offset	1 1/4" FP - 2" SP, 1 1/4" & 1 1/2" 3-Way SL Valves
V25153138BL	2" x 1 3/8" Handle Offset	2" & 3" 3-Way BL Valves
V25153138	2" x 1 3/8" Handle Offset	2" FP Valve & 2" 3-Way SL Valves



We are here to serve you. Just call or email with your project specifications and details, and we'll do the rest. Our goal is to provide the best solution for your project, with materials delivered on time at a price that fits nicely within your budget.

POLY NOZZLE VALVES

BOLTED POLY NOZZLE VALVE



Light weight hose end valve for convenient transfer of liquids. Angled end flange with 8" long poly fill spout.

Part #
BJVA150FP
BJVA200STD

Part #
BJVA200FP

POLY DISPENSING NOZZLE



- Glass filled polypropylene
- Stainless steel handle, spring & pin
- Viton rubber parts
- Resists corrosion
- Padlock capacity
- 75 PSI

Part #
BJVN100

Repair Kit Part #
VN-10200

SINGLE UNION ANGLE VALVE



Part #
BJUVA100FP
1" Nozzle Pipe Only
V-10161

BOLTED POLY NOZZLE VALVE



Part #
SHP-VA100
1" Nozzle Pipe Only
V-10161

ANSI FLANGE VALVE 2" FULL PORT



- Stainless steel bolts
- All teflon seats
- Glass filled polypropylene
- Light weight
- ANSI flange connection
- Compact design

BJVSMT200FPAF
2" male pipe thread
x 2" ANSI flange

Part #	Ball Opening	Pipe Size
BJVSMT200FPAF	2"	2"
AF200G	2" ANSI flange gasket	

POLY BOTTOM LOAD VALVE

Part #	Size	Opening Thru Ball
BJBLV075	3/4"	1"
BJBLV100	1"	1"
BJBLV125	1 1/4"	1 1/2"
BJBLV150	1 1/2"	1 1/2"
BJBLV200	2"	2"

Directional flow either right or left. Valve can be turned off to stop flow.



POLY SIDE LOAD VALVE

Part #	Size	Opening Thru Ball
BJSLV075	3/4"	1"
BJSLV100	1"	1"
BJSLV125	1 1/4"	1 1/2"
BJSLV150	1 1/2"	1 1/2"
BJSLV200	2"	2"

Directional flow either right or left. Valve can't be turned off.



LOCKING DEVICE

Part #
VL-20153

Locking device for V125FP, V150FP & V200STD



LOCKING DEVICE

Part #
VL-25153

Locking handle for V200FP, V300STD, V300FP & V400STD



MOUNTING BRACKETS



304 Stainless Steel

BOTH FIT V150FP, V200FP, V300STD, & V300FP

Part #	Size/Description
V25270	Straight Mounting Bracket
V25271	90° Mounting Bracket

HOSE END VALVE HANDLE



NEW!

- Fits most 2" and 3" Valves
- Fits Banjo and Norwesco Valves
- Utilizes Existing Valve Bolts
- Powder Coat Tough Skin Paint

Part #	Description
5078819-CBK	Universal Valve Handle





"STUBBY VALVES" STANDARD PORT BALL VALVES



Part # Description
BJVSF200 2" Male Adapter x 2" Female NPT Thread

BJVSF300 3" Male Adapter x 3" Female NPT Thread



Part # Description
BJVSM200 2" Male NPT Thread x 2" Female NPT Thread

BJVSM300 3" Male NPT Thread x 3" Female NPT Thread



Part # Description
BJVSFMT200 2" Male Adapter x 2" Male NPT Thread

BJVSFMT300 3" Male Adapter x 3" Male NPT Thread



"STUBBY VALVE" 2" FULL PORT BALL VALVES



Part # Description
BJVSM204FP 2" Male NPT Thread x 2" Female NPT Thread

BJVSF204FP 2" Male Adapter x 2" Female NPT Thread



Part # Description
BJVSFMT204FP 2" Male Adapter x 2" Male NPT Thread

BJVS204FP 2" x 2" Female NPT Thread



2" FULL PORT STAINLESS STEEL MANIFOLD "STUBBY" VALVES



MVS220HSFP



MVSF220HSFP



MVSF220SS

Part #	Description	Max PSI	Pipe Size	Opening Thru Ball
MVS220HSFP	2" FP Flange x 2" FP Flange w/ SS Ball, Stem & Handle	200	2"	2"
MVSF220HSFP	2" FP Flange x 2" Male NPT w/ SS Ball, Stem & Handle Max PSI 200, PIPC Size 2", Open Thru Ball 2"	150	2"	2"



3" FULL PORT STAINLESS STEEL MANIFOLD "STUBBY" VALVES



MVS300HSFP



MVVF300HSFP



MVSMT300HSFP

Part #	Description	Max PSI	Pipe Size	Opening Thru Ball
MVS300HSFP	3" FP Flange x 3" FP Flange w/SS Ball, Stem & Handle	100	3"	3"
MVVF300HSFP	3" FP Flange x 3" Male Adapter w/SS Ball, Stem & Handle	100	3"	3"
MVSMT300HSFP	3" FP Flange x 3" Male NPT w/SS Ball, Stem & Handle	200	3"	3"



3" FULL PORT BALL VALVES "STUBBY VALVES"

SINGLE UNION POLY VALVES



Part #	Description
BJVSFMT300FP	3" FP Male Adapter x 3" Male NPT Thread
BJVSFMT300HSFP	3" FP Male Adapter x 3" Male NPT W/SS Ball, Stem & Handle

Part #	Size
BJUV050FP	1/2"
BJUV075FP	3/4"
BJUV100FP	1"
BJUV125FP	1 1/4"
BJUV150FP	1 1/2"
BJUV200FP	2"

We are here to serve you. Just call or email with your project specifications and details, and we'll do the rest. Our goal is to provide the best solution for your project, with materials delivered on time at a price that fits nicely within your budget.

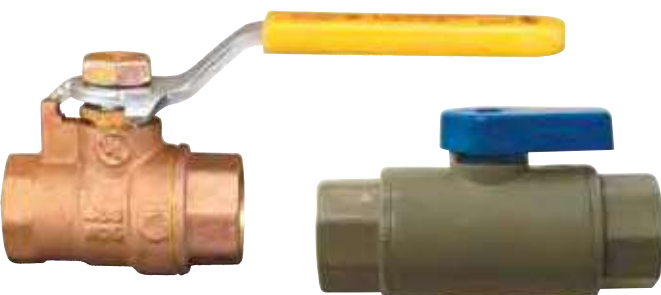

BRASS BALL VALVES

Part #	Size/Description
5143197	1/2" Brass Ball Valve
5143190	3/4" Brass Ball Valve
5143191	1" Brass Ball Valve
5143211	3/8" Brass Ball Valve
5143226	1/4" PVC Valve

DRY-MATES, SPIKE & CHECK VALVES



DRY MATE

Part #	Description
DM150A	1 1/2" Male Dry-Mate
DM150D	1 1/2" Female Dry-Mate
DM200A	2" Male Dry-Mate
DM200D	2" Female Dry-Mate Full Port
DM220A	2" Male Dry-Mate Full Port
DM220D	2" Female Dry-Mate
DM200CAP	Dust Cap For Male Fits 1 1/2" & 2"
DM200PL	Dust Cap For Female Fits 1 1/2" & 2"



- Minimal fluid loss when disconnected
- Effective for closed system transfers and chemical
- Prevents accidental spills & exposure

DRY POPPET COUPLINGS

Part #	Description
DPCF100	Female Dry Poppet Coupler, 1" Female NPT Threads FKM (Viton Type) Seals
DPCM100	Male Dry Poppet Adapter, 1" Female NPT Threads FKM (Viton Type) Seals
DPCMT100	Male Dry Poppet Adapter With 2" Male Threaded Body, 1" Female NPT Threads FKM (Viton Type) Seals

POLYPROPYLENE CHECK VALVES



Part #	Description
CV100MT	1" Male x Female NPT
CV221	2" Full Port Check Valve
CV300	3" Full Port Check Valve

POLYPROPYLENE CHECK VALVE



Part #	Description	Max PSI	Pipe Size
MCV100	1" Flanged Poly Check Valve	300	1"
MCV200	2" Flanged Poly Check Valve	300	1 1/2"
MCV221	2" Full Port Poly Check Valve	200	2"
MCV300	3" Flanged Poly Check Valve	200	3"



2" FULL PORT (316) SS DRY-MATE

Part #	Description
DM220ASS	2" FP Male, NPT Threads, All PTFE Seals
DM220DSS	2" FP Female, NPT Threads, FKM Seals

STAINLESS STEEL CHECK VALVE



Part #	Size
CVSE375	3/8" SS Check Valve w/ Viton O-Ring
CVSE50	1/2" SS Check Valve w/ Viton O-Ring
CVSE75	3/4" SS Check Valve w/ Viton O-Ring
CVSE100	1" SS Check Valve w/ Viton O-Ring
CVSE125	1 1/4" SS Check Valve w/ Viton O-Ring
CVSE150	1 1/2" SS Check Valve w/ Viton O-Ring
CVSE200	2" SS Check Valve w/ Viton O-Ring
CVSE300	3" SS Check Valve w/ Viton O-Ring
CVSE400	4" SS Check Valve w/ Viton O-Ring

MANIFOLD PRESSURE SPIKE VALVES



Part #	Description	Pressure Spikes
MPRV100-050	1" x 1" Pressure Spike Valve	50 P.S.I.
MPRV100-075	1" x 1" Pressure Spike Valve	75 P.S.I.
MPRV100-100	1" x 1" Pressure Spike Valve	100 P.S.I.
MPRV100-125	1" x 1" Pressure Spike Valve	125 P.S.I.
MPRV100-150	1" x 1" Pressure Spike Valve	150 P.S.I.

PVC INLINE CHECK VALVES



Part #	Size
210-303	1/2"
210-304	3/4"
210-305	1"
210-306	1 1/4"
210-307	1 1/2"
210-308	2"

CAM LEVER COUPLINGS & MICRO VALVES

POLY CAM LEVER COUPLINGS

Part #	Description	Max PSI	Gasket	Qty
201B	2" Female Coupler - 2" Extended Male Thread	200	EPDM	1
303B	3" Female Coupler - 3" Extended Male Thread	150	EPDM	1
303C	3" Female Coupler w/3 Arms - 3" Hose Shank	200	EPDM	1



QDC ADAPTER COUPLINGS

Part #	Description	Max PSI	Gasket	Qty
200FF	2" Male Adapter - 2" Male Adapter	150	N/A	10/ bag
300F200F	3" Male Adapter - 2" Male Adapter	75	N/A	1
300FF	3" Male Adapter - 3" Male Adapter	75	N/A	1
303B200A	3" Female Coupler w/3 Arms - 2" Male Adapter	200	EPDM	1



LOCKING MICRO VALVES



Part #	Description
LV038050MTLV	3/8" Female x 1/2" Male NPT Locking Micro Valve
LV050100MTLV	1/2" Female x 1" Male NPT Locking Micro Valve

Part #	Description
LVHB075MTLV	3/4" HB x 3/4" Male NPT Locking Micro Valve
LVHB075100MTLV	3/4" HB x 1" Male NPT Locking Micro Valve

Part #	Description
LV050SLLV	1/2" Side Load Locking Micro Valve

POLY MICRO VALVES



Part #	Description
LVPL025V	1/4" Push-To-Connect Micro Valve
LVPL038V	3/8" Push-To-Connect Micro Valve
LVPL050V	1/2" Push-To-Connect Micro Valve
LVPL038MPTV	3/8" Push-To-Connect x 3/8" MPT Micro Valve
LVPL038025MPTV	3/8" Push-To-Connect x 1/4" MPT Micro Valve

Part #	Description
LVHB038050MTV	3/8" HB X 1/2" MPT Micro Valve
LVHB075MTV	3/4" HB X 3/4" MPT Micro Valve
LVHB075100MTV	3/4" HB X 1" MPT Micro Valve



Part #	Description
LV025M	1/4" FPT X 1/4" MPT Micro Valve
LV038M	3/8" FPT X 3/8" MPT Micro Valve
LV038050M	3/8" FPT X 1/2" MPT Micro Valve
LV050M	1/2" FPT X 1/2" MPT Micro Valve
LV050100M	1/2" FPT X 1" MPT Micro Valve



Part #	Description
LV025V	1/4" FPT X 1/4" FPT Micro Valve
LV038V	3/8" FPT X 3/8" FPT Micro Valve
LV050V	1/2" FPT X 1/2" FPT Micro Valve
LV050SLV	1/2" FPT Side Load Micro Valve

CAM LEVER COUPLINGS



90° CAM LEVER COUPLINGS

A90°

**MALE ADAPTER X
FEMALE NPT 90°**



Size	Part #	Part #
1 1/2"	61293	150A90
2"	61296	200A90

C90°

**FEMALE ADAPTER X
HOSE SHANK 90°**



Size	Part #	Part #
1 1/2"	61299	150C90
2"	61301	200C90

D90°

**FEMALE ADAPTER X
FEMALE NPT 90°**



Size	Part #	Part #
1 1/2"	61300	150D90
2"	61302	200D90

F90°

**MALE ADAPTER X
MALE NPT 90°**



Size	Part #	Part #
1 1/2"	61289	150F90
2"	61291	200F90

POLY LANYARD

Part #

V20207

Description

11" Polyurethane rubber lanyard



- Strong and durable
- Corrosion resistant



We are here to serve you. Just call or email with your project specifications and details, and we'll do the rest. Our goal is to provide the best solution for your project, with materials delivered on time at a price that fits nicely within your budget.

To see our wide variety of nurse trailer models: [Nurse Trailer Line Card \(pdf\)](#).

POLY CAM LEVER COUPLINGS

MALE ADAPTER X FEMALE NPT

A

Size	Norwesco Part #	Banjo Part #
1/4"	-	75A1/4
1/2"	61199	75A1/2
3/4"	61207	75A3/4
1"	61215	100A
1 1/4"	61223	125A
1 1/2" x 1 1/4"	-	150125A
1 1/2"	61231	150A
2"	61239	200A
3"	61247	300A
4"	62789	400A



FEMALE COUPLER X MALE NPT

B

Size	Norwesco Part #	Banjo Part #
1/2"	61255	75B1/2
3/4"	61259	75B3/4
1"	61263	100B
1 1/4"	61267	125B
1 1/2" x 1 1/4"	-	150125B
1 1/2"	61271	150B
2"	61275	200B
2"	-	201B*
3"	61279	300B
3"	-	303B*
4"	62790	400B



* EXTENDED MALE THREAD

FEMALE COUPLER X HOSE SHANK

C

Size	Norwesco Part #	Banjo Part #
1/2"	61256	050C
3/4"	61260	075C
1"	61264	100C
1 1/4"	61268	125C
1 1/2" x 1 1/4"	-	150125C
1 1/2"	61272	150C
2" x 1 1/2"	-	200150C
2"	61276	200C
3"	61280	300C
3"	-	303C
4"	62791	400C



Banjo 303C Has 3 Cam Arms

FEMALE COUPLER X FEMALE NPT

D

Size	Norwesco Part #	Banjo Part #
1/2"	61257	050D
3/4"	61261	075D
1"	61265	100D
1 1/4"	61269	125D
1 1/2" x 1 1/4"	-	150125D
1 1/2"	61273	150D
2"	61277	200D
3"	61281	300D
4"	62792	400D



ALSO AVAILABLE IN STAINLESS STEEL, ALUMINUM, HARD COAT ALUMINUM & NYGLASS. CALL FOR PRICING

COUPLER ARM SAFETY LOCK®



PT Coupling Company

Size	Part #
2"	77015
3"	77013
4"	77014

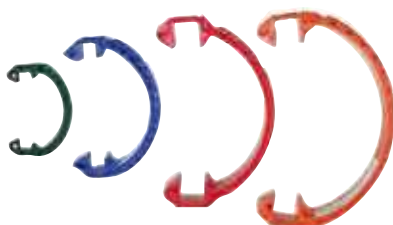

POLY CAM LEVER COUPLINGS

MALE ADAPTER X HOSE SHANK



Size	Norwesco Part #	Banjo Part #
1/2"	61203	050E
3/4"	61211	075E
1"	61219	100E
1 1/4"	61227	125E
1 1/2" x 1 1/4"	-	150125E
1 1/2"	61235	150E
2"	61243	200E
3"	61251	300E
4"	62793	400E



E

MALE ADAPTER X MALE NPT



Size	Norwesco Part #	Banjo Part #
1/2"	61204	050F
3/4"	61212	075F
1"	61220	100F
1 1/4"	61228	125F
1 1/2" x 1 1/4"	-	150125F
1 1/2"	61236	150F
2"	61244	200F
2"	-	200F45
3"	61252	300F
4"	62794	400F



F

FEMALE CAP

Size	Norwesco Part #	Banjo Part #
1/2"	61258	075CAP
1"	61266	100125CAP
1 1/2"	61274	150CAP
2"	61278	200CAP
2 1/2"	-	250CAP
3"	61282	300CAP
4"	62795	400CAP



CAP

FEMALE CAP WITH HANDLE

Size	Part #	Code #	Description
2"	77021	5149172	Hose Female Cap w/Handle
3"	77023	5149174	Hose Female Cap w/Handle
4"	77025	5149176	Hose Female Cap w/Handle



MALE PLUG

Size	Norwesco Part #	Banjo Part #
1/2"	61214	75PL
1"	61222	100125PL
1 1/2"	61238	150PL
2"	61246	200PL
3"	61254	300PL
4"	62796	400PL



PLUG

MALE PLUG WITH HANDLE

Size	Part #	Code #	Description
2"	77020	5149171	Hose Male Plug w/Handle
3"	77022	5149173	Hose Male Plug w/Handle
4"	77024	5149175	Hose Male Plug w/Handle



POLYPROPYLENE PIPE FITTINGS



Features

- Precision molded in polypropylene
- Glass reinforced for stability, strength and toughness
- Hose barbs are molded specifically to fit into hoses

- Sizes range from 1/4" to 4"
- Combination sizes available
- Excellent chemical resistance
- Pressure to 150 PSI at 70°

HOSE BARBS



Part #	MPT	HB
HB025	1/4"	1/4"
HB025038	1/4"	3/8"
HB038	3/8"	3/8"
HB038050	3/8"	1/2"
HB050038	1/2"	3/8"
HB050	1/2"	1/2"
HB050075	1/2"	3/4"
HB075038	3/4"	3/8"
HB075050	3/4"	1/2"
HB075058	3/4"	5/8"
HB075	3/4"	3/4"
HB075100	3/4"	1"
HB100075	1"	3/4"
HB100	1"	1"
HB100125	1"	1 1/4"
HB125075	1 1/4"	3/4"
HB125100	1 1/4"	1"
HB125	1 1/4"	1 1/4"
HB125150	1 1/4"	1 1/2"
HB150100	1 1/2"	1"
HB150125	1 1/2"	1 1/4"
HB150	1 1/2"	1 1/2"
HB150200	1 1/2"	2"
HB200150	2"	1 1/2"
HB200	2"	2"
HB300	3"	3"
HB400	4"	4"

HOSE MENDERS



Part #	MPT	HB
HM050	1/2"	1/2"
HM075	3/4"	3/4"
HM100	1"	1"
HM125	1 1/4"	1 1/4"
HM150	1 1/2"	1 1/2"
HM200	2"	2"
HM300	3"	3"

HOSE BARB TEES



Part #	HB X MPT
HBT050038	1/2" x 1/2" x 3/8"
HBT050075	1/2" x 1/2" x 3/4"
HBT075050	3/4" x 3/4" x 1/2"
HBT075	3/4"
HBT075100	3/4" x 3/4" x 1"
HBT100075	1" x 1" x 3/4"
HBT100	1"
HBT200	2" x 2" x 2"
HBT300	3" x 3" x 3"

HOSE BARB TEE X MPT



Part #	MPT	HB
HBT150100	1 1/2"	1"
HBT150150	1 1/2"	1 1/2"

REDUCING NIPPLES



Part #	MPT	MPT
RN050038	1/2"	3/8"
RN075050	3/4"	1/2"
RN100050	1"	1/2"
RN100075	1"	3/4"
RN125075	1 1/4"	3/4"
RN125100	1 1/4"	1"
RN150100	1 1/2"	1"
RN150125	1 1/2"	1 1/4"
RN200125	2"	1 1/4"
RN200150	2"	1 1/2"
RN300200	3"	2"

REDUCER COUPLINGS



Part #	FPT	FPT
RC100075	1"	3/4"
RC150100	1 1/2"	1"
RC150125	1 1/2"	1 1/4"
RC200050	2"	1/2"
RC200100	2"	1"
RC200125	2"	1 1/4"
RC200150	2"	1 1/2"
RC300200	3"	2"

90° HOSE BARBS



Part #	MPT	HB
HB02590	1/4"	1/4"
HB02503890	1/4"	3/8"
HB03890	3/8"	3/8"
HB05003890	1/2"	3/8"
HB05090	1/2"	1/2"
HB05007590	1/2"	3/4"
HB07505090	3/4"	1/2"
HB07590	3/4"	3/4"
HB07510090	3/4"	1"
HB10007590	1"	3/4"
HB10090	1"	1"
HB10012590	1"	1 1/4"
HB12510090	1 1/4"	1"
HB12590	1 1/4"	1 1/4"
HB15090	1 1/2"	1 1/2"
HB15012590	1 1/2"	1 1/4"
HB20090	2"	2"
HB20015090	2"	1 1/2"
HB30090	3"	3"

PIPE NIPPLES



Part #	MPT	HB
NIP025SH	1/4"	SHORT
NIP038SH	3/8"	SHORT
NIP050SH	1/2"	SHORT
NIP0503	1/2"	3"
NIP075SH	3/4"	SHORT
NIP0754	3/4"	4"
NIP0756	3/4"	6"
NIP100SH	1"	SHORT
NIP1004	1"	4"
NIP1006	1"	6"
NIP125SH	1 1/4"	SHORT
NIP1254	1 1/4"	4"
NIP1256	1 1/4"	6"
NIP150SH	1 1/2"	SHORT
NIP1503	1 1/2"	3"
NIP1504	1 1/2"	4"
NIP1505	1 1/2"	5"
NIP1506	1 1/2"	6"
NIP200SH	2"	SHORT
NIP2004	2"	4"
NIP2006	2"	6"
NIP300SH	3"	SHORT
NIP3004	3"	4"
NIP3006	3"	6"
NIP400SH	4"	SHORT

COUPLINGS



Part #	FPT
CPLG038	3/8"
CPLG050	1/2"
CPLG075	3/4"
CPLG100	1"
CPLG125	1 1/4"
CPLG150	1 1/2"
CPLG200	2"
CPLG300	3"

THREADED PLUGS



Part #	FPT
PLUG050	1/2"
PLUG075	3/4"
PLUG100	1"
PLUG125	1 1/4"
PLUG150	1 1/2"
PLUG200	2"
PLUG300	3"

HOSE MENDER ELBOW



Part #	Description
HBEL10090	1" HB x 1" HB
HBEL15010090	1 1/2" HB x 1" MPT

POLYPROPYLENE PIPE FITTINGS



Features

- Precision molded in polypropylene
- Glass reinforced for stability, strength and toughness
- Hose barbs are molded specifically to fit into hoses

- Sizes range from 1/4" to 4"
- Combination sizes available
- Excellent chemical resistance
- Pressure to 150 PSI at 70°

REDUCER BUSHINGS



Part #	MPT	HB
RB038025	3/8"	1/4"
RB050025	1/2"	1/4"
RB050038	1/2"	3/8"
RB075018	3/4"	1/8"
RB075025	3/4"	1/4"
RB075038	3/4"	3/8"
RB075050	3/4"	1/2"
RB100025	1"	1/4"
RB100050	1"	1/2"
RB100075	1"	3/4"
RB125038	1 1/4"	3/8"
RB125075	1 1/4"	3/4"
RB125100	1 1/4"	1"
RB150075	1 1/2"	3/4"
RB150100	1 1/2"	1"
RB150125	1 1/2"	1 1/4"
RB200075	2"	3/4"
RB200100	2"	1"
RB200125	2"	1 1/4"
RB200150	2"	1 1/2"
RB300150	3"	1 1/2"
RB300200	3"	2"
RB400300	4"	3"

STREET ELBOWS 45°



Part #	MPT	FPT
SL07545	3/4"	3/4"-45°
SL10045	1"	1"-45°
SL12545	1 1/4"	1 1/4"-45°
SL15045	1 1/2"	1 1/2"-45°
SL20045	2"	2"-45°
SL30045	3"	3"-45°

CAPS



Part #	FPT
CAP050	1/2"
CAP075	3/4"
CAP100	1"
CAP125	1 1/4"
CAP150	1 1/2"
CAP200	2"
CAP300	3"

45° ELBOWS



Part #	MPT	FPT
EL10045	1"	1"-45°

POLY SWIVELS

Part #	MPT	FPT
SW100	1"	1"
SW150	1 1/2"	1 1/2"
SW200	2"	2"



Features:

- Hex flats
- Viton O-rings
- 75 PSI maximum
- Teflon thrust bearing
- Stainless steel drive stud
- Heavy duty reinforced polypropylene.

90° ELBOWS



Part #	FPT	FPT
EL03890	3/8"	3/8"-90°
EL05090	1/2"	1/2"-90°
EL07590	3/4"	3/4"-90°
EL10090	1"	1"-90°
EL12590	1 1/4"	1 1/4"-90°
EL15090	1 1/2"	1 1/2"-90°
EL20090	2"	2"-90°
EL30090	3"	3"-90°

TEES



Part #	FPT	FPT
TEE038	3/8"	3/8"
TEE050	1/2"	1/2"
TEE075	3/4"	3/4"
TEE100	1"	1"
TEE125	1 1/4"	1 1/4"
TEE150	1 1/2"	1 1/2"
TEE200	2"	2"
TEE300	3"	3"

HOSE BARBS



Part #	FPT	HB
HBF075	3/4"	3/4"
HBF075100	3/4"	1"
HBF100	1"	1"

STREET ELBOWS



Part #	MPT	FPT
SL03890	3/8"	3/8"-90°
SL05090	1/2"	1/2"-90°
SL07590	3/4"	3/4"-90°
SL10090	1"	1"-90°
SL12590	1 1/4"	1 1/4"-90°
SL15090	1 1/2"	1 1/2"-90°
SL20090	2"	2"-90°
SL30090	3"	3"-90°

CROSSES



Part #	FPT
CR075	3/4"
CR100	1"
CR125	1 1/4"
CR150	1 1/2"
CR200	2"

SUCTION BASKET STRAINER



Part #	Description
TSS25	2" strainer
TSS35	3" strainer

GAUGE TEES



Part #	FPT	FPT
TEG100	1"	1"

1/4" female thread gauge port on top of tee

POLY VENT CAP / ANTI VORTEX



Part #	Description
VC230	2" cap with 12 mesh screen
VC300	3" cap no screen
VC330	3" cap with 10 mesh screen

MANIFOLD VALVES

Features

- Positive Seals
- Quick & Easy Assembly
- Easy On/Off Hose Connections
- 360° Orientation
- No Threads, No Sealant, No Pipe Tape

Sizes

- 100 Series-1" Full Port
- 200 Series-2" Standard Port (1 1/2" Flow)
- 220 Series-2" Full Port
- 300 Series-3" Full Port



Part #	Description
BJVSMT200CF	2" Flange x 2" Male NPT Standard Port Ball Valve
MVSMT300	3" Manifold Flange x 3" Male NPT Thread



Part #	Description
BJVSF200CF	2" Flange x 2" Male Adapter Standard Port Ball Valve



Part #	Description
MVS220FP	2" Full Port Flange x 2" Female Thread Stubby Ball Valve



Part #	Description
MV100CF	1" x 1" Flange Ball Valve
MV200CF	2" x 2" Standard Port Flange Ball Valve
MV220CF	2" x 2" Full Port Flange Ball Valve
MVS220CF	2" x 2" Full Port Flange Stubby Ball Valve



Part #	Description
MVSF220FP	2" Full Port Flange x 2" Male Adapter Stubby Ball Valve
MVSF300	3" Manifold Flange x 3" Male Adapter
MVSF300FP	3" Full Port Flange x 3" Male Adapter Stubby Ball Valve



Part #	Description
MV300CF	3" Flange x 3" Flange Ball Valve
MV300BL	3" Flange 3-Way Bottom Load Valve

Part #	Description
DM200ACF	2" Std Port Flange-Male Dry-Mate
DM200DCF	2" Std Port Flange-Female Dry-Mate
DM200A	Threaded
DM200D	Threaded
DM300ACF	3" Flanges Male with FKM Seals
DM300DCF	3" Female Mainfold Dry-Mate

DM200ACF & DM200DCF



MANIFOLD VALVES & FLOW METERS

MANIFOLD LINE STRAINERS



- EPDM Gaskets
- 304 Stainless Steel Screens
- 150 PSI Maximum

MANIFOLD 1" & 2" STANDARD PORT "T" STRAINERS

Part #	Description	Max PSI
MLST100-30	1" Flanged "T" Strainer - 30 Mesh	300
MLST100-50	1" Flanged "T" Strainer - 50 Mesh	300
MLST100-80	1" Flanged "T" Strainer - 80 Mesh	300
MLST100-100	1" Flanged "T" Strainer - 100 Mesh	300
MLST150-16	2" Standard Port "T" Strainer - 16 Mesh	225
MLST150-30	2" Standard Port "T" Strainer - 30 Mesh	225
MLST150-50	2" Standard Port "T" Strainer - 50 Mesh	225
MLST150-80	2" Standard Port "T" Strainer - 80 Mesh	225
MLST150-100	2" Standard Port "T" Strainer - 100 Mesh	225



- EPDM Gaskets
- 316 Stainless Steel Screens
- 150 PSI Maximum



MANIFOLD 1" "Y" STRAINERS

Part #	Description	Max PSI
MLS100-20	1" Full Port Flanged "Y" Strainer - 20 Mesh	225
MLS100-40	1" Full Port Flanged "Y" Strainer - 40 Mesh	225
MLS100-80	1" Full Port Flanged "Y" Strainer - 80 Mesh	225

MANIFOLD 2" "Y" STRAINERS

Part #	Description	Max PSI
MLS200BC	2" Standard Port Flanged "Y" Strainer Body & Cap 2" Body, Bowl, Drain Plug, 2 O-rings, Plug & Gasket	225
MLS200-06	2" Standard Port Flanged "Y" Strainer - 6 Mesh	225
MLS200-20	2" Standard Port Flanged "Y" Strainer - 20 Mesh	225
MLS200-30	2" Standard Port Flanged "Y" Strainer - 30 Mesh	225
MLS200-50	2" Standard Port Flanged "Y" Strainer - 50 Mesh	225
MLS200-80	2" Standard Port Flanged "Y" Strainer - 80 Mesh	225
MLS200-100	2" Standard Port Flanged "Y" Strainer - 100 Mesh	225
MLS200-120	2" Standard Port Flanged "Y" Strainer - 120 Mesh	225



- EPDM Gaskets
- 316 Stainless Steel Screens
- 150 PSI Maximum



MANIFOLD 2" FULL PORT "Y" STRAINERS

Part #	Description	Max PSI
MLS222BC	2" Full Port Flanged Body & Cap Less Screen 2" Body, Bowl, Drain Plug, 2 O-rings, Plug & Gasket	150
MLS222-04	2" Full Port Flanged "Y" Strainer - 4 Mesh	150
MLS222-10	2" Full Port Flanged "Y" Strainer - 10 Mesh	150
MLS222-16	2" Full Port Flanged "Y" Strainer - 16 Mesh	150
MLS222-30	2" Full Port Flanged "Y" Strainer - 30 Mesh	150
MLS222-50	2" Full Port Flanged "Y" Strainer - 50 Mesh	150
MLS222-80	2" Full Port Flanged "Y" Strainer - 80 Mesh	150
MLS222-100	2" Full Port Flanged "Y" Strainer - 100 Mesh	150

MANIFOLD LINE STRAINERS

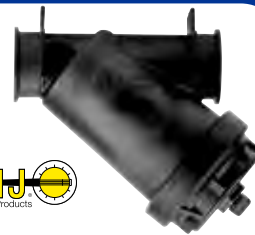

- EPDM Gaskets
- 304 Stainless Steel Screens
- 75 PSI Maximum



Part #	Description	Max PSI
MLS300-08	3" Manifold Line Strainer - 8 Mesh	100
MLS300-12	3" Manifold Line Strainer - 12 Mesh	100
MLS300-20	3" Manifold Line Strainer - 20 Mesh	100
MLS300-50	3" Manifold Line Strainer - 50 Mesh	100

POLY AIR ACTUATED SHUTOFF VALVES



Part #	Description	Max PSI	Pipe Size	Handle Type
PV075	3/4" x 3/4" Poly Pinch Valve	70	3/4"	N/A
PV100	1" X 1" Poly Pinch Valve	70	1"	N/A
PV100-075	1" x 3/4" Poly Pinch Valve	70	1 x 3/4"	N/A
PV100-075V	1" x 3/4" FKM (viton Poly Pinch Valve type)	70	1 x 3/4"	N/A
PV100-075B	1" x 3/4" Poly Pinch B CPLG Valve	70	1 x 3/4"	N/A

3-WAY BOTTOM LOAD POLY VALVE



Direction flow, right or left. Valve can be turned off to stop flow.

Part #	Description	Max PSI	Pipe Size	Handle Type
MV100BL	1" Flanges x 1" FPT Inlet	300	1"	T
MV200BL	2" Std Port Flanges x 1 1/2" Inlet	225	2"	T
MV220BL	2" Full Port Flanges x 2" FPT Inlet	150	2"	S
MV300BL	3" Full Port Flanges x 3" FPT Inlet	150	3"	S

3-WAY SIDE LOAD POLY VALVE



Directional flow, right or left. Valve cannot be turned off.

Part #	Description	Max PSI	Pipe Size	Handle Type
MV100SL	1" Flanges x 1" FPT Inlet	100	1"	T
MV200SL	2" Std Port Flanges x 1 1/2" Inlet	100	2"	S
MV220SL	2" Full Port Flanges x 2" FPT Inlet	100	2"	S

POLY "T" LINE STRAINERS

- Heavy glass reinforced polypropylene
- Clean-out plug
- 304 stainless steel reinforced screen
- EPDM gaskets
- 150 PSI at 70° F

The 2" strainer features a 316 stainless steel head with a glass reinforced bowl and viton gaskets



EXCELLENT CHOICE

Part #	Description
BJLST07516	3/4" w/ 16 mesh screen
BJLST07530	3/4" w/ 30 mesh screen
BJLST07550	3/4" w/ 50 mesh screen
BJLST07580	3/4" w/ 80 mesh screen
BJLST075100	3/4" w/ 100 mesh screen
BJLST10016	1" w/ 16 mesh screen
LST100-30	1" w/ 30 mesh screen
BJLST10050	1" w/ 50 mesh screen
BJLST10080	1" w/ 80 mesh screen
BJLST100100	1" w/ 100 mesh screen
BJLST12516	1 1/4" w/ 16 mesh screen
BJLST12530	1 1/4" w/ 30 mesh screen
BJLST12550	1 1/4" w/ 50 mesh screen
BJLST12580	1 1/4" w/ 80 mesh screen
BJLST125100	1 1/4" w/ 100 mesh screen
BJLST15016	1 1/2" w/ 16 mesh screen
BJLST15030	1 1/2" w/ 30 mesh screen
BJLST15050	1 1/2" w/ 50 mesh screen
BJLST15080	1 1/2" w/ 80 mesh screen
BJLST150100	1 1/2" w/ 100 mesh screen
BJLST20030SS	2" w/ 30 mesh screen
BJLST20050SS	2" w/ 50 mesh screen
BJLST20080SS	2" w/ 80 mesh screen
BJLST200100SS	2" w/ 100 mesh screen

Banjo "T" Line Strainer Repair Parts 3/4" to 2"

Size of T-line Strainer	EPDM Gasket	VITON Gasket	Head, Bowl, & Gasket	Strainer Head Only	Strainer Bowl Only	Clean Out Plug Only	O-Ring For Plug	4 Mesh Screen
ITEM#	4	4	1	2	3	6	7	5
3/4"	LST100-G	LST100-GV	LST075-HB	LST075-HB	LST100-B	12777	UV-15163	-
1"	LST100-G	LST100-GV	LST100-HB	LST100-HB	LST100-B	12777	UV-15163	-
1 1/4"	LST150-G	LST150-GV	LST125-HB	LST125-HB	LST150-B	LSQ200-PL	LSQ200R	-
1 1/2"	LST150-G	LST150-GV	LST150-HB	LST150-HB	LST150-B	LSQ200-PL	LSQ200R	-
2"	-	LST200-GV	LST200HBSS	LST200HBSS	LST200-B	LSQ200-PL	LSQ200R	LST204SS

Banjo "T" Line Strainer Repair Parts 3/4" to 2" Continued

Size of T-line Strainer	6 Mesh Screen	8 Mesh Screen	10 Mesh Screen	16 Mesh Screen	30 Mesh Screen	50 Mesh Screen	80 Mesh Screen	100 Mesh Screen
ITEM#	5	5	5	5	5	5	5	5
3/4"	-	-	-	LST116	LST130	LST150	LST180	LST1100
1"	-	-	-	LST116	LST130	LST150	LST180	LST1100
1 1/4"	-	-	-	LST1516	LST1530	LST1550	LST1580	LST15100
1 1/2"	-	-	-	LST1516	LST1530	LST1550	LST1580	LST15100
2"	LST206SS	LST208SS	LST210SS	LST216SS	LST230SS	LST250SS	LST280SS	LST2100SS



POLY MINI "T" LINE STRAINERS

1/2" & 3/4" Mini T-Strainers

Part #	Size	Description	Qty
LSTM050-30	1/2" x 1/2"	Black Bowl Strainer - 30 Mesh Screen	1
LSTM050-30	1/2" x 1/2"	Black Bowl Strainer - 30 Mesh Screen	1
LSTM050-30C	1/2" x 1/2"	Clear Bowl Strainer - 30 Mesh Screen	1
LSTM050-80	1/2" x 1/2"	Black Bowl Strainer - 80 Mesh Screen	1
LSTM050-100	1/2" x 1/2"	Black Bowl Strainer - 100 Mesh Screen	1
LSTM050-50C	1/2" x 1/2"	Clear Bowl Strainer - 50 Mesh Screen	1
LSTM050-80C	1/2" x 1/2"	Clear Bowl Strainer - 80 Mesh Screen	1
LSTM050-100C	1/2" x 1/2"	Clear Bowl Strainer - 100 Mesh Screen	1
LSTM075-30	3/4" x 3/4"	Black Bowl Strainer - 30 Mesh Screen	1
LSTM075-50	3/4" x 3/4"	Black Bowl Strainer - 50 Mesh Screen	1
LSTM075-80	3/4" x 3/4"	Black Bowl Strainer - 80 Mesh Screen	1
LSTM075-100	3/4" x 3/4"	Black Bowl Strainer - 100 Mesh Screen	1
LSTM075-30C	3/4" x 3/4"	Clear Bowl Strainer - 30 Mesh Screen	1
LSTM075-50C	3/4" x 3/4"	Clear Bowl Strainer - 50 Mesh Screen	1
LSTM075-80C	3/4" x 3/4"	Clear Bowl Strainer - 80 Mesh Screen	1
LSTM075-100C	3/4" x 3/4"	Clear Bowl Strainer - 100 Mesh Screen	1

NEW ISO COLOR SYSTEM

Mesh Size	RAL #	Mesh Size	RAL #
6	White	50	Gentian Blue
8	Zinc Yellow	60	Gentian Blue
12	Black	80	Zinc Yellow
16	Brown Red	100	Traffic Green
20	Beige	120	Black
30	Flame Red	150	Pure Orange
40	Brown		



NORWESCO T-LINE STRAINERS

Part #	Description
NWTLS05020	1/2" w/ 20 mesh screen
NWTLS05040	1/2" w/ 40 mesh screen
NWTLS05080	1/2" w/ 80 mesh screen
NWTLS07520	3/4" w/ 20 mesh screen
NWTLS07540	3/4" w/ 40 mesh screen
NWTLS07580	3/4" w/ 80 mesh screen
NWTLS10020	1" w/ 20 mesh screen
NWTLS10080	1" w/ 80 mesh screen



with top mounting tabs

T-Line Strainer Parts

Size	EPDM Gasket	TLS Body Less Screen	20 Mesh Screen	40 Mesh Screen	80 Mesh Screen
1/2"	61537	61283	61404	61405	61406
3/4"	61537	61284	61404	61405	61406
1"	61537	61285	61404	61405	61406

BANJ QUICK DISCONNECT Y-LINE STRAINER

Part #	Description
BJLSQ15006	1 1/2" LSQ 06 mesh screen
BJLSQ15012	1 1/2" LSQ 12 mesh screen
BJLSQ15020	1 1/2" LSQ 20 mesh screen
BJLSQ15030	1 1/2" LSQ 30 mesh screen
BJLSQ15050	1 1/2" LSQ 50 mesh screen
BJLSQ15080	1 1/2" LSQ 80 mesh screen
BJLSQ150120	1 1/2" LSQ 120 mesh screen
BJLSQ20006	2" LSQ 06 mesh screen
BJLSQ20012	2" LSQ 12 mesh screen
BJLSQ20020	2" LSQ 20 mesh screen
BJLSQ20030	2" LSQ 30 mesh screen
BJLSQ20050	2" LSQ 50 mesh screen
BJLSQ20080	2" LSQ 80 mesh screen



- Precision molded in glass reinforced polypropylene
- Cam lever configuration for easy access for cleaning and servicing
- 3/4" plug in cam lever cap for attaching ball valve for draining or back flushing
- Stainless steel or poly screens available
- EPDM lathe cut gasket
- 75 PSI maximum

NEW ISO COLOR SYSTEM

Mesh Size	RAL #
6	White
8	Zinc Yellow
12	Black
16	Brown Red
20	Beige
30	Flame Red
40	Brown
50	Gentian Blue
60	Gentian Blue
80	Zinc Yellow
100	Traffic Green
120	Black
150	Pure Orange

Banjo LSQ Y-Line Strainer Repair Parts

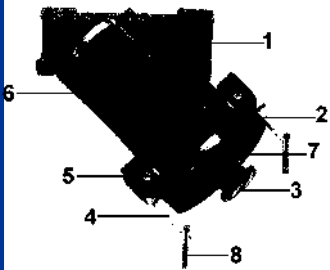

Size of LSQ	EPDM Gasket	Body/Cap	Cap	Plug	O-Ring For Plug	SS Cam	SS Cam Arm
ITEM#	2	1 & 7	7	3	N/A	4	5
1 1/2"	LSQ200G	LSQ150BC	LSQ200C	PLUG075S	LSQ200R	300K	300P
2"	LSQ200G	LSQ200BC	LSQ200C	PLUG075S	LSQ200R	300K	300P

Banjo LSQ Y-Line Strainer Repair Parts Continued

Size of LSQ	Ring Pin	6 Mesh SS Screen	12 Mesh SS Screen	20 Mesh SS Screen	30 Mesh SS Screen	50 Mesh SS Screen	80 Mesh SS Screen
ITEM#	8	6	6	6	6	6	6
1 1/2"	15ORING	LS206	LS212	LS220	LS230	LS250	LS280
2"	15ORING	LS206	LS212	LS220	LS230	LS250	LS280

BANJ 3" 304 STAINLESS STEEL LINE STRAINER

3" SS "Y" Strainer Parts

Item #	Part #	Description
1 & 2	LSS300BC	SS body, cap, & gaskets
1	LSS300B	SS body only
3	LSS300S	Screen Seal (2 per strainer)
4	LSS300G	Replacement gasket for cap
5	LSS300H	Handle / clamp assembly
6	LSS306	6 mesh screen SS
6	LSS320	20 mesh screen SS

- EPDM Rubber Gasket
- Corrosion Resistant
- 200 PSI Maximum

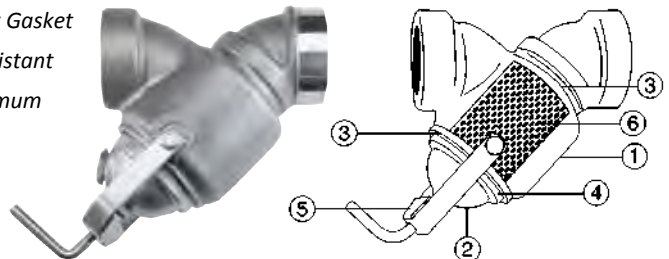

When ordering the 3" stainless steel line strainer the screen must be ordered separately. It is not included in the strainer price.

POLYPROPYLENE LINE STRAINERS

Polypropylene Line Strainers

Description	Norwesco	Banjo
1/2" w/ 20 mesh screen	64169	LS050-20
1/2" w/ 40 mesh screen	64170	LS050-40
1/2" w/ 80 mesh screen	64171	LS050-80
3/4" w/ 20 mesh screen	64173	LS075-20
3/4" w/ 40 mesh screen	64174	LS075-40
3/4" w/ 80 mesh screen	64175	LS075-80
1" w/ 20 mesh screen	61478	LS100-20
1" w/ 40 mesh screen	-	LS100-40
1" w/ 80 mesh screen	61480	LS100-80
1 1/4" w/ 20 mesh screen	61738	LS125-20
1 1/4" w/ 40 mesh screen	61740	LS125-40
1 1/4" w/ 80 mesh screen	61741	LS125-80
1 1/2" w/ 06 mesh screen	-	LS150-06
1 1/2" w/ 12 mesh screen	-	LS150-12
1 1/2" w/ 20 mesh screen	61488	LS150-20
1 1/2" w/ 30 mesh screen	-	LS150-30
1 1/2" w/ 50 mesh screen	-	LS150-50
1 1/2" w/ 80 mesh screen	61490	LS150-80
1 1/2" w/ 120 mesh screen	-	LS150-120
2" w/ 06 mesh screen	-	LS200-06
2" w/ 12 mesh screen	-	LS200-12
2" w/ 20 mesh screen	61493	LS200-20
2" w/ 30 mesh screen	-	LS200-30
2" w/ 50 mesh screen	-	LS200-50
2" w/ 80 mesh screen	61495	LS200-80
2" w/ 120 mesh screen	-	LS200-120
3" w/ 04 mesh screen	-	LSM300-04
3" w/ 06 mesh screen	62337	-
3" w/ 08 mesh screen	-	LSM300-08
3" w/ 12 mesh screen	62338	LSM300-12
3" w/ 20 mesh screen	62339	LSM300-20
3" w/ 40 mesh screen	62340	-
3" w/ 50 mesh screen	-	LSM300-50



- 1/2" to 1 1/4" 75 PSI - 1 1/2" to 2" 150 PSI
- 304 Stainless steel screens
- Clean-out plug on 1-1/2" and 2" strainers



3" poly "Y" strainer to be used on suction side or non-pressure side in all applications



Banjo Poly "Y" Line Strainer Replacement Parts

Size of Y-Line Strainer	Y-Body/Cap (Less screen)	Y-Body only	Sq. Gasket (new style)	O-Ring (old style)	End Cap (new style)	Clean Out Plug	O-ring for the plug	4 mesh SS Screen
ITEM#	1 & 3	1	2	2	3	5	6	4
1/2"	LS050BC1	-	LS075-G	-	LS075-C1	12723	12724	-
3/4"	LS075BC1	-	LS075-G	-	LS075-C1	12723	12724	-
1"	LS100BC1	-	LS100-GV	-	LS100-C1	12777	UV-15163	-
1 1/4"	LS125BC1	-	LS100-G	-	LS100-C1	12777	UV-15163	-
1 1/2"	LS150BC	-	LS150-G	LS200-G	LS150-C	LSQ200-PL	LSQ200R	-
2"	LS200BC	-	LS150-G	LS200-G	LS150-C	LSQ200-PL	LSQ200R	-
3"	LS300C2 Cap Only	-	LS300-G1	LS300-G	LS300C2	13777	13778	LS304
3"	-	-	LS300GV1	LS300GV	-	-	-	-



Old style strainer use LS-200C end cap.

Banjo Poly "Y" Line Strainer Replacement Parts Continued

Size of Y-Line Strainer	6 mesh SS Screen	8 mesh SS Screen	12 mesh SS Screen	20 mesh SS Screen	30 mesh SS Screen	40 mesh SS Screen	50 mesh SS Screen	80 mesh SS Screen	120 mesh SS Screen
ITEM#	4	4	4	4	4	4	4	4	4
1/2"	-	-	-	LS720	-	LS740	-	LS780	-
3/4"	-	-	-	LS720	-	LS740	-	LS780	-
1"	-	-	-	LS120	-	LS140	-	LS180	-
1 1/4"	-	-	-	LS120	-	LS140	-	LS180	-
1 1/2"	LS206	-	LS212	LS220	LS230	-	LS250	LS280	LS2120
2"	LS206	-	LS212	LS220	LS230	-	LS250	LS280	LS2120
3"	-	LS308	LS320	LS320	-	-	LS350	-	-

PUSH-TO-CONNECT FITTINGS



QUICK TEEJET PUSH TO CONNECT FITTINGS

Part #	Description
QJ98595-1/4-2	Push to Connect QJ Body & Cap, 1/4", 2 PSI (0.14 bar) check valve
QJ98595-1/4-10	Push to Connect QJ Body & Cap, 1/4", 10 PSI (0.69 bar) check valve
QJ98594-3/8-2	Push to Connect QJ Body & Cap, 3/8", 2 PSI (0.14 bar) check valve
QJ98588-1/4	Push to Connect QJ Cap, 1/4" w/ gasket
QJ98592-1/4-2	Push to Connect QJ Body, 1/4", 2 PSI (0.14 bar) check valve
QJ98592-1/4-10	Push to Connect QJ Body, 1/4", 10 PSI (0.69 bar) check valve
QJ98586-3/8	Push to Connect QJ Cap, 3/8" w/ gasket
QJ98590-3/8-2	Push to Connect QJ Body, 3/8", 2 PSI (0.14 bar) check valve
QJ98590-3/8-10	Push to Connect QJ Body, 3/8", 10 PSI (0.69 bar) check valve
QJ98599-90-3/8	Push to Connect 90° QJ Cap
QJ98598-90-1/4	Push to Connect 90° QJ Cap
QJ114403-1/4	Push to Connect 90° QJ Swivel Cap
QJ114404-5/16	Push to Connect 90° QJ Swivel Cap
QJ114405-3/8	Push to Connect 90° QJ Swivel Cap
QJ114398-5/16	Push to Connect QJ Cap
QJ114430-1/4-#	Push to Connect x Push to Connect Body
QJ114432-5/16-#	Push to Connect x Push to Connect Body
QJ114434-3/8-#	Push to Connect x Push to Connect Body



QJ98590 and QJ98592



QJ98586 and QJ98588 Cap



MANIFOLD TUBING

Part #	Description
2T20-0403N-100	Tubing, 11/64 ID w/1/4" OD NATURAL
2T20-0403BK-100	Tubing, 11/64 ID w/1/4" OD BLACK
2T20-0403G-100	Tubing, 11/64 ID w/1/4" OD GREEN
2T20-0403Y-100	Tubing, 11/64 ID w/1/4" OD YELLOW
46428	3/16" x 1/4" BLUE
2T20-0604BK-100	Tubing, 1/4" ID w/3/8" OD BLACK
2T20-0604N-100	Tubing, 1/4" ID w/3/8" OD NATURAL
2T20-0503BK-100	Tubing, 5/16" OD Black



Available in:
 - 100 ft Rolls
 - 1000 ft Rolls
 Please specify when ordering.

GAS ENGINE CONVERSION CHART FROM HP TO MODEL

HONDA

HP	Model #
4 HP	GX120
5.5 HP	GX160
6 HP	GX200
8 HP	GX240
9 HP	GX270
11 HP	GX340
13 HP	GX390

BRIGGS

HP	Model #
3.5 HP	800 Series
5.5 HP	900 Series
6.5 HP	950 Series
8 HP	1550 Series
11 HP	1650 Series

REPLACEMENT ENGINES

CALL FOR PRICING & SEASONAL SPECIALS

Part #	Part #	Starter	Crank Shaft Size	Oil Alert
GX120UT1QX2	5152081	Rewind	3/4" keyway	yes
GX120K1TX2	5152059	Rewind	5/8" threaded	yes
** GX160UT1QX2	5152058	Rewind	3/4" keyway	yes
GX160K1QXE2		Electric Start	3/4" keyway	yes
GX160K1HX2		6:1 Gear Reduction Box, Carb		yes
GX160UT2TX2		Rewind	5/8" threaded	yes
GX200UTQX2	5152088	Rewind	3/4" keyway	yes
GX240K1QA2	5152089	Rewind	1" keyway	yes
GX240U1QAE2	5152090	Electric & Rewind	1" keyway	yes
GX270QA2	5152092	Rewind	1" keyway	yes
GX340U1QA2	5152078	Rewind	1" keyway	yes
GX340U1QAE2	5152094	Electric & Rewind	1" keyway	yes
GX390UT1QA2	5152095	Rewind	1" keyway	yes
GX390U1QAE2	5152096	Electric & Rewind	1" keyway	yes

**Banjo replacement pump engines. •18 hp & 20 hp engines do not include the gas tank or exhaust system. NOT AVAILABLE IN CALIFORNIA

Part#	Description
5152099	Briggs & Stratton 6:1 Reduction Unit, 900 Series, 3/4" keyway
5152080	Honda 6:1 Reduction Unit, 3/4" keyway



GX160UT1QX2



GX390U1QAE2



GX160K1HX
6:1 Reduction

6.5 HP & 13 HP ENGINES

PowerPro Gasoline Engine, Recoil Start

Part #	Description
2541-0045	3/4" Keyed Shaft; 6.5 HP engine

PowerPro Gasoline Engines, Electric Start

2541-0049	1" Keyed Shaft; 13 HP engine
-----------	------------------------------



LEESON ELECTRIC MOTORS TEFC

Part #	H.P.	Phase	R.P.M.	Voltage	Frame
131533	3	1°	1740	230	184T
131538	5	1°	1740	230	184T
131549	5	1°	3500	230	184T
G130008	3	3°	1760	230/460	182T
G120185	3	3°	3490	230/460	145T
131464.00	5	3°	1750	230/460	184T
131987.00	5	3°	3510	230/460	184T
G130103	7.5	3°	3505	230/460	213T
G150159	10	3°	3510	230/460	215T
G150033	20	3°	3540	230/460	256T



CAST IRON CENTRIFUGAL SELF-PRIMING PUMP



Part #	Size	Engine	HP	Starter	GPM
200PI6PRO	2"	Briggs	950 Series	Rewind	160
200PIH5-KIT	2"	Honda	GX160	Rewind	160
300PIH8	3"	Honda	GX240	Rewind	200
300PIH13	3"	Honda	GX390	Electric	

Do not run pumps dry, restrict or reduce port sizes or dead head pumps. This could cause component failure to pump.

REPLACEMENT ENGINES

Part #	Description
GX160UT1QX2	Honda GX160 engine only
GX390UT2QA2	Honda GX390 engine only
GX160UT2QE2	Honda GX160 electric start engine only
GX390UT2QAE2	Honda GX390 electric start engine only



GX160UT1QX2



GX390UT2QAE2

HYDRAULIC DRIVEN CAST IRON PUMPS WITH HYDRAULIC MOTOR

Part #	Description
200PIHY	2" hydraulic driven cast pump (Min 6 gal / Max 10 / 12 HP Motor/ Open System)
300PIHY	3" hydraulic driven cast pump (Min 9 gal / Max 13 / 21 HP Motor/ Open System)



CAST IRON PUMP ONLY

(for use with gas engines - includes bolt package & support Z rails)

Part #	Description
150POI	1 1/2" cast pump only
200POI	2" cast pump only
300POI	3" cast pump only

POI - pump only is shipped complete and ready for attachment to a gasoline engine.



CAST IRON PUMP PEDESTAL MOUNTED

(for use with electric motors)

Part #	Description
200PBI	2" cast pump w/ pedestal
300PBI	3" cast pump w/ pedestal

PBI - Pedestal pump is easily adaptable to electric power





WET SEAL PUMPS STAINLESS STEEL, CAST IRON & POLY



- Viton double seal contained in ethylene glycol reservoir
- Sight tube indicator
- Dynamic balanced impeller
- All Stainless steel hardware
- Available in 316 stainless steel or cast iron with bearing pedestal, gas engine or pump only

Cast Iron

Wet Seal Self-Priming Cast Iron Centrifugal Pumps

Part #	Size	Engine	HP	GPM
201PIH5W	2"	Honda	GX160	160
301PIH13W-KIT	3"	Honda	GX390	350
M332PIH13W	3"	Honda	GX390	360

Wet Seal Cast Iron Pump ONLY (for use with gas engine)

201POIW	2" cast iron pump only 3/4" shaft
301POIW	3" cast iron pump only 1" shaft

Wet Seal Cast Iron Pedestal Pump ONLY (for use with electric motor)

201PBIW	2" pump/bearing pedestal 3/4" shaft
---------	-------------------------------------

Wet Seal Pump Units

200PBI3HP1W-KIT	2" cast iron pump / wet seal
-----------------	------------------------------



- "V" shaped for quicker priming.
- Double seal contained in ethylene glycol reservoir. Carbon Ceramic seal faces with stainless steel cup — spring with EPDM rubber.
- Large weep holes between pump end and engine.
- New Compact Design!
- Pump end separated from engine. Run Dry Capability!



Poly

Wet Seal Self-Priming Poly Pumps

Part #	Size	Engine	HP	GPM
200PH5W	2"	HONDA	GX160	160
200P6PROW	2"	BRIGGS	950 SERIES	160
M220PH5W	M220	HONDA	GX160	160
300PH6W	3"	HONDA	GX200	300
M300PH6W	M300	HONDA	GX200	300
300P11PROW	3"	BRIGGS	1650 SERIES	320

2" & 3" Poly Wet Seal Pump Only

Part #	Description
205POWW	2" Poly Wet Seal Pump Only, 5 Vane Impeller W/ FKM Seals
300POW6	3" Poly Wet Seal Pump Only 3/4" Shaft



Poly

2" Poly Manifold Wet Seal Pump W/ Hydraulic Motor

Part #	Description
M220PHYW	2" Poly Manifold Wet Seal Pump W/ Hydraulic Motor



STAINLESS STEEL PUMPS



All 316 stainless steel wetable internal components: impeller, sleeve, wear plate, fasteners. 316 stainless steel housing, carbon ceramic seal.

Hydraulic Driven 316 Stainless Steel Pumps

Part #	Description
200PHYSS	2" hydraulic driven SS pump
300PHYSS	3" hydraulic driven SS pump

2" Stainless steel pump complete with Gresen MGG2 hydraulic motor.



3" Stainless steel pump complete with Tyrone UM16 hydraulic motor.



316 Stainless Steel Pump ONLY (for use with gas engine)

Part #	Description
200POSS	2" 316 SS pump only - 3/4" shaft sleeve
300POSS	3" 316 SS pump - 1" shaft sleeve

316 Stainless Steel Pedestal Pumps (for use with electric motor)

200PBSS	2" pump/bearing pedestal 3/4" shaft
300PBSS	3" pump/bearing pedestal 1" shaft

HYPRO® ROLLER PUMPS



1700C



6500C



7560C



7700C

Hypro Roller Pumps

Part #	Max GPM	Max PSI	Max RPM	Description
1502C	62.1	150	1000	Cast iron 6-roller pump with Super Rollers, Buna-N Seals, 1 1/2" NPT ports, and 15/16" solid shaft.
1502N	62.1	150	1000	Ni-Resist 6-roller pump with Super Rollers, Buna-N seals, 1 1/2" NPT ports, and 15/16" solid shaft.
1502XL	62.1	150	1000	Silver Cast 6-roller pump with Super Rollers, Viton seals, 1 1/2" NPT ports, and 15/16" solid shaft.
1700C	45.0	200	1000	Cast iron 5-roller pump with Super Rollers, Viton seals, 1" NPT ports, and 15/16" solid shaft.
1700N	45.0	200	1000	Ni-Resist 5-roller pump with Super Rollers, Viton seals, 1" NPT ports, and 15/16" solid shaft.
1700XL	45.0	200	1000	Silver Cast 5-roller pump with Super Rollers, Viton seals, 1" NPT ports, and 15/16" solid shaft.
6500C*	21.8	300	1200	Cast iron 6-roller pump with Super Rollers, Super Rotor, Viton seals, 3/4" NPT ports, and 5/8" solid shaft.
6500N*	21.8	300	1200	Ni-Resist 6-roller pump with Super Rollers, Super Rotor, Viton seals, 3/4" NPT ports, and 5/8" solid shaft.
6500XL*	21.8	300	1200	Silver Cast 6-roller pump with Super Rollers, Super Rotor, Viton seals, 3/4" NPT ports, and 5/8" solid shaft.
7560C*	22.5	300	1000	Cast iron 8-roller pump with Super Rollers, Super Rotor, Viton seals, 3/4" NPT ports, and 15/16" solid shaft.
7560N*	22.5	300	1000	Ni-Resist 8-roller pump with Super Rollers, Super Rotor, Viton seals, 3/4" NPT ports, and 15/16" solid shaft.
7560XL*	22.1	300	1000	Silver Cast 8-roller pump with Super Rollers, Viton seals, 3/4" NPT ports, and 15/16" solid shaft.
7560XL-GM30*	20.1	300	1000	Same as 7560XL, coupled to an SAE 2 bolt A flanged, low speed, high torque hydraulic motor. 3 cubic inch motor displacement, 12 G.P.M. hydraulic flow maximum
7700C*	22.1	200	800	Cast iron 7-roller pump with Super Rollers, Super Rotor, Viton seals, 3/4" NPT ports and 15/16" solid shaft.
7700N*	22.1	200	800	Ni-Resist 7-roller pump with Super Rollers, Super Rotor, Viton seals, 3/4" NPT ports, and 5/16" solid shaft.
7700XL*	22.1	200	800	Silver Cast 7-roller pump with Super Rollers, Super Rotor, Viton seals, 3/4" NPT ports, and 15/16" solid shaft.

* These pumps now come standard with the super rollers & metallic rotor

HYPRO®

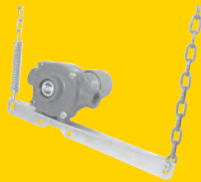

5271623



3430-0592

Hypro Torque Arm Kit (Pump Not Included)

Part #	Material	RPM	For Pump Series	Description
5271623	steel	540/1000	1700, 6500, 7560, 7700, 9600	Torque Bar & Chain Kit

Hypro 12V Clutch

Part #	Shaft Size	Pulley Type	Max HP	Max RPM	Hypro Pump Model
3430-0592	5/8"	5.00"-A	30	5000	9202C, 9203C, 9204C, 9203C-R, 9262C, 9263C-C, 9263C-CR, 9203C-SP, 9262S-C, 9263S-C, 9263S-CR, 9263C-C-SP, 9263C-CR-SP
2526-0011	7/8"	5.25"-A	30	5000	9203P, 9253P-C, 9500P-S, 9205C, 9205C-SP



4001N



4101XL



4101N-AEH



4001C



5277100

Hypro Series 4001 & 4101 Roller Pumps

Part #	Max GPM	Max PSI	Max RPM	Description
4001C	9.1	150	1800	Cast iron 4-roller pump with Super Rollers, Viton seals, 3/4" NPT ports and 5/8" solid shaft.
4001C-H	9.1	150	1800	4001C pump with 1/2" hollow shaft.
4001N	9.1	150	1800	Ni-Resist 4 roller pump with Super Rollers, Viton seals, 3/4" NPT ports, and 5/8" solid shaft.
4001N-H	9.1	150	1800	4001N pump with 1/2" hollow shaft.
4001N-EH	10.4	30	1900	12 Volt DC motor-driven, Ni-resist 4 roller pump with Super. Rollers, Viton seals, 3/4" NPT ports, 1/2" hollow shaft.
4001XL	9.1	150	1800	SilverCast 4-roller pump with Super Rollers Viton seals, 3/4" NPT ports, and 5/8" solid shaft
4001XL-H	9.1	150	1800	SilverCast 4001XL pump with 1/2" hollow shaft.
4001XL-EH	10.4	30	1900	12 Volt DC motor-driven, SilverCast, 4-roller pump with Super Rollers, Viton Seals, 3/4" NPT ports, 1/2" hollow shaft.
4101C	7.2	150	2600	Cast iron 4-roller pump with Super Rollers, Viton seals, 3/4" NPT ports, and 5/8" solid shaft.
4101C-H	7.2	150	2600	4101C pump with 1/2" hollow shaft.
5277100	7.2	150	2600	4101C Pump with Briggs & Stratton Engine
4101N	7.2	150	2600	Ni-Resist 4-roller pump with Super rollers, Viton seals, 3/4" NPT ports, and 5/8" solid shaft.
4101N-EH	7.5	50	1900	12 Volt DC motor-driven, Ni-Resist, 4-roller pump with Super Rollers, Viton seals, 3/4" ports, 1/2" hollow shaft
4101XL	7.2	150	2600	SilverCast 4-roller pump with Super Rollers, Viton seals, 3/4" NPT ports, and 5/8" solid shaft.
4101XL-H	7.2	150	2600	SilverCast 4101XL pump with 1/2" hollow shaft.
4101XL-25	8.9	150	2600	PowerPro 2.5 HP

Add "A" behind part number for super rollers & metallic rotor

HYPRO®



1320-0016



1321-0006



1323-0076

Hypro Quick Couplers (Female to Female)

Part #	PTO (I.D.)	Pump End (I.D.)	Material	RPM	For Pump Series
1320-0015	3/4"	5/8"	steel	-	4000, 6500
1320-0016	5/8"	5/8"	steel	-	4000, 6500
1320-0022	1 3/8" (6 spline)	5/8"	die cast	540	6500
1321-0006	1 3/8" (6 spline)	5/8"	die cast	540	6500
1321-0007	1 3/8" (6 spline)	15/16"	die cast	540	1500, 1700, 7560, 7700
1321-0012	1 3/8" (multi-speed)	5/8"	die cast	540/1000	4000, 6500
1321-0013	1 3/8" (multi-speed)	15/16"	die cast	540/1000	1500, 1700, 7560, 7700
1323-0072	1 3/8" (6 spline)	15/16"	forged steel	540	1500, 1700, 7560, 7700
1323-0073	1 3/8" (21 spline)	15/16"	forged steel	1000	1500, 1700, 7560
1323-0074	1 3/8" (6 spline)	5/8"	forged steel	540	6500
1323-0075	1 3/8" (21 spline)	5/8"	forged steel	1000	4000, 6500
1323-0076	1 3/8" (multi-speed)	15/16"	forged steel	540/1000	1500, 1700, 7560, 7700
1323-0077	1 3/8" (multi-speed)	5/8"	forged steel	540/1000	4000, 6500
1320-0080	1 3/4" (20 spline)	15/16"	forged steel	1000	1500, 1700, 7560

HYPRO®



9200C

Hypro Series 9200 Cast Iron, Pedestal Mount Models

Part #	Max GPM	Max PSI	Max RPM	Description
9202C	105	170	6000	Pedestal mount 1 1/4" inlet 1" outlet NPT ports. Cast iron pump with 5/8" solid shaft and Viton shaft seal.
9203C	140	170	6000	Pedestal mount cast iron pump with 5/8" solid shaft and Viton shaft seal. 1-1/2" inlet; 1-1/4" outlet NPT ports.
9203C-R	140	170	6000	Pedestal mount clockwise rotation cast iron pump, with 5/8" solid shaft, Viton seal. 1-1/2" x 1-1/4" NPT ports.
9205C	180	190	4200	Pedestal mount cast iron pump with 7/8" solid shaft and Viton seal. 2" inlet; 1 1/2" outlet NPT ports.
3430-0332				Seal and o-ring repair kit
3430-0537				Seal and o-ring kit for 9205C models

HYPRO® GEAR DRIVEN PUMPS



9000C



9000P

Hypro Series 9000 Gear-Driven Models

Part #	Max GPM	Max PSI	Max RPM	Description
9006C-O	117	78	600	Cast iron pump with oil lubricated gear drive and 1 3/8" 540 RPM female PTO hub w/locking collar and mounting clip. Clips pump to PTO shield of most tractors. 1 1/2" inlet, 1 1/4" outlet.
9008C-O	115	76	1000	Cast iron pump with oil lubricated gear drive and 1 3/8" 1000 RPM female PTO hub w/locking collar and mounting clip. Clips pump to PTO shield of most tractors. 1 1/2" inlet, 1 1/4" outlet.
9016C-O	117	78	600	Cast iron pump with oil lubricated gear drive and 1" solid shaft, ports (NPT): 1 1/2" inlet, 1 1/4" outlet.
9018C-O	115	76	1000	Cast iron pump with oil lubricated gear drive and 1" solid shaft, ports (NPT): 1 1/2" inlet, 1 1/4" outlet.
9028C-O	115	76	1000	Cast iron pump with oil lubricated gear drive and 1 3/4" 1000 RPM female PTO hub w/locking collar and mounting clip. Clips pump to PTO shield of most tractors. 1 1/2" inlet, 1 1/4" outlet.
9006P-O	97	83	600	Corrosion-resistant and durable polypropylene pump with oil-bath-lubricated gear drive for PTO mounting. Vitonseals and 1 3/8" 540 RPM female PTO hub w/locking collar kit.
3430-0333				Seal and O-ring repair kit for polypropylene models.
3430-0334				Seal and O-ring repair kit for cast iron models.
3430-0456				Vent line kit with 25' long, 1/4" ID vinyl hose, 1/8" NPT x 1/4" HB 90° nylon elbow fitting, 1/8" NPT x 1/4" HB straight polypropylene fitting, plastic hose clamp and plastic cable tie.

HYPRO® MOTOR DRIVEN PUMPS



9303C-HM4C-SP



9305C-HM3C-SP

Hypro Series 9303 & 9305 Cast Iron & Stainless Steel Hydraulic-Motor-Driven, Self-Priming Models

Part #	Max GPM Output	Max PSI	Hyd GPM Required	Description
9303C-HM4C-SP	99	97	7	Hydraulic motor/cast iron pump for closed/open center systems, ports (NPT): 1-1/2" inlet, 1-1/4" outlet.
3430-0589				Seal and o-ring repair kit.
9305C-HM3C-SP	155	143	19	Hydraulic motor/cast iron pump for closed center systems, ports (NPT): 2" inlet, 2" outlet.
3430-0601				Life Guard® silicon carbide seal kit.
3430-0481SP				Self priming chamber kit.

Life Guard® silicon carbide seal - Add suffix "B" (i.e.: 9303C-HM1C-SP-B)

HYPRO® PEDESTAL MOUNT, CLUTCH-DRIVEN CAST IRON & STAINLESS STEEL



9263S-CR



9263C-C

Hypro Series 9263 Cast Iron & Stainless Steel Clutch Driven Model

Part #	Max GPM	Max PSI	Max RPM	PM	Description
9263C-C	140	114	5000	Cast	Pedestal Mount, CCW Rotation, ports (NPT): 1-1/2" inlet, 1-1/4" outlet
9263C-CR	140	114	5000	Cast	Pedestal Mount, CW Rotation, ports (NPT): 1-1/2" inlet, 1-1/4" outlet
9263S-CR	140	114	5000	316 Stainless	Pedestal Mount, CW Rotation, ports (NPT): 1-1/2" inlet, 1-1/4" outlet
3430-0332					Seal and o-ring repair kit.
3430-0589					Life Guard® silicon carbide seal kit.

† Universal Flange (220 x 200) - Add Suffix "U" (i.e.: 9263C-C-U)

Life Guard silicon carbide seal - Add suffix "B" (i.e.: 9263C-CB)

*CCW (counterclockwise) CW (clockwise) are determined when looking at the shaft end.

HYPRO[®] MOTOR DRIVEN PUMPS



9303C-HM4C



9302S



9305C-HM3C



9307

Hypro Series 9300 Cast Iron & Stainless Steel Hydraulic-Motor-Driven Models

Part #	Max GPM Output	Max PSI	Hyd GPM Required	Description
9302C-HM1C	72	140		Hydraulic motor/cast iron pump, ports (NPT): 1 1/4" inlet, 1" outlet.
9302C-HM2C	65	90		Hydraulic motor/cast iron pump, ports (NPT): 1 1/4" inlet, 1" outlet.
9302C-HM4C	72	110		Hydraulic motor/cast iron pump, ports (NPT): 1 1/4" inlet, 1" outlet.
9302S-HM4C	72	110		Hydraulic motor/stainless steel pump, ports (NPT): 1 1/4" inlet, 1" outlet.
9303C-HM1C	114	130	13	Hydraulic motor/cast iron pump for open/closed center systems, ports (NPT): 1 1/2" inlet, 1 1/4" outlet.
9303C-HM2C	97	95	6	Hydraulic motor/cast iron pump for closed center systems, ports (NPT): 1 1/2" inlet, 1 1/4" outlet.
9303C-HM3C	125	98	24	Hydraulic motor/cast iron pump for large open center systems, ports (NPT): 1 1/2" inlet, 1 1/4" outlet.
9303C-HM4C	115	93	7	Hydraulic motor/cast iron pump for closed/open center systems, ports (NPT): 1 1/2" inlet, 1 1/4" outlet.
9303C-HM5C	147	145	16	Hydraulic motor/cast iron pump for closed/open center systems, ports (NPT): 1 1/2" inlet, 1 1/4" outlet.
9303S-HM1C	114	130	13	Hydraulic motor/stainless steel pump for open/closed center systems, ports (NPT): 1 1/2" inlet, 1 1/4" outlet.
9303S-HM2C	97	95	6	Hydraulic motor/stainless steel pump for closed center systems, ports (NPT): 1 1/2" inlet, 1 1/4" outlet.
9303S-HM4C	115	93	7	Hydraulic motor/stainless steel pump for closed/open center systems, ports (NPT): 1 1/2" inlet, 1 1/4" outlet.
9305C-HM3C	182	156	19	Hydraulic motor/cast iron pump for closed/open center systems, ports (NPT): 2" inlet, 1 1/2" outlet.
3430-0500				Seal and o-ring repair kit.
3430-0601				Life Guard [®] silicon carbide seal kit.
9306C-HM1C	207	130	13	Hydraulic motor/cast iron pump for closed/open center systems, ports (NPT). 2" inlet, 1 1/2" outlet.
9306C-HM1C-BU-005	207	130	13	Hydraulic motor/cast iron pump for closed/open center systems, ports (NPT). 300 x 220 Flange
9306C-HM3C	214	135	24	Hydraulic motor/cast iron pump for closed/open center systems, ports (NPT). 2" inlet, 1 1/2" outlet.
9306C-HM5C	212	140	17	Hydraulic motor/cast iron pump for closed/open center systems, ports (NPT). 2" inlet, 1 1/2" outlet.
9306S-HM1C	207	130	13	Hydraulic motor/cast iron pump for closed/open center systems, ports (NPT). 2" inlet, 1 1/2" outlet.
9306S-HM5C	212	140	17	Hydraulic motor/cast iron pump for closed/open center systems, ports (NPT). 2" inlet, 1 1/2" outlet.
3430-0332				Seal and o-ring repair kit.
3430-0589				Life Guard [®] silicon carbide seal kit.
9307C-GM10	370	135	20	Hydraulic motor/cast iron pump for closed/open center systems, ports (NPT): 3" inlet, 2" outlet.
3430-0604				Life Guard [®] silicon carbide seal kit.
9306C-HM1C-BU	207	130	13	Hydraulic motor/cast iron pump for closed/open center systems, ports: 220 series flange & Lifeguard seal.
9306C-HM1C-BU-002	207	130	13	Hydraulic motor/cast iron pump, ports 220 series flange w/Lifeguard seal & integrated PWM.
93100-001	283	127	13	316 Stainless Steel pump, ports: 300 flange x 220 flange w/Lifeguard seal & integrated PWM.
3430-0332				Seal and o-ring repair kit.
3430-0589				Life Guard silicon carbide seal kit.

Universal Flange (220 x 200) - Add suffix "U" (i.e.: 9303C-HMC-U)

Life Guard[®] silicon carbide seal - Add suffix "B" (i.e.: 9303C-HM1C-B)

HYPRO[®] FORCEFIELD™ WET SEAL PUMPS

- ForceField Technology is a superior wet seal technology that provides the ultimate protection for the mechanical seal and avoids costly downtime
- Protects the mechanical seal against common failures related to dry run and chemical bonding by using a barrier fluid to keep it cool and lubricated
- Actively maintains a pressure differential between the barrier fluid and the pumping solution, which results in longer life and worry free operation
- Capable of flows up to 311 GPM (1177 LPM) and can produce up to 150 PSI (10.3 bar)
- Designed to be a drop-in replacement for standard Hypro hydraulically driven centrifugal pumps
- One year warranty covering pump, motor and seals



Hypro Series 9310 Cast Iron & Stainless Steel Hydraulic-Motor-Driven Wet Seal Models

Part #	Current Product Equivalent	Max GPM Output	Max PSI	Hy d GPMRequired	Description
9313C-M04	9303C-HM2C	140	90	7	Hydraulic motor cast iron wet seal pump, ports: 1-1/2" NPT x 1-1/4" NPT
9313CU-M04	9303C-HM2C-U	140	90	7	Hydraulic motor cast iron wet seal pump, ports: 220 x 200 Universal Flange
9313C-M05	9303C-HM4C	155	100	8	Hydraulic motor cast iron wet seal pump, ports: 1-1/2" NPT x 1-1/4" NPT
9313CU-M05	9303C-HM4C-U	155	100	8	Hydraulic motor cast iron wet seal pump, ports: 220 x 200 Universal Flange
9313C-M08	9303C-HM1C	188	137	13	Hydraulic motor cast iron wet seal pump, ports: 1-1/2" NPT x 1-1/4" NPT
9313CU-M08	9303C-HM1C-U	188	137	13	Hydraulic motor cast iron wet seal pump, ports: 220 x 200 Universal Flange
9313C-M10	9303C-HM5C	197	150	16	Hydraulic motor cast iron wet seal pump, ports: 1-1/2" NPT x 1-1/4" NPT
9313CU-M10	9303C-HM5C-U	197	150	16	Hydraulic motor cast iron wet seal pump, ports: 220 x 200 Universal Flange
9313C-M16	9303C-HM3C	194	103	20	Hydraulic motor cast iron wet seal pump, ports: 1-1/2" NPT x 1-1/4" NPT
9313CU-M16	9303C-HM3C-U	194	103	20	Hydraulic motor cast iron wet seal pump, ports: 220 x 200 Universal Flange
9313S-M04	9303S-HM2C	140	90	7	Hydraulic motor stainless steel wet seal pump, ports: 1-1/2" NPT x 1-1/4" NPT
9313SU-M04	9303S-HM2C-U	140	90	7	Hydraulic motor stainless steel wet seal pump, ports: 220 x 200 Universal Flange
9313S-M05	9303S-HM4C	155	100	8	Hydraulic motor stainless steel wet seal pump, ports: 1-1/2" NPT x 1-1/4" NPT
9313SU-M05	9303S-HM4C-U	155	100	8	Hydraulic motor stainless steel wet seal pump, ports: 220 x 200 Universal Flange
9313S-M08	9303S-HM1C	188	137	13	Hydraulic motor stainless steel wet seal pump, ports: 1-1/2" NPT x 1-1/4" NPT
9313SU-M08	9303S-HM1C-U	188	137	13	Hydraulic motor stainless steel wet seal pump, ports: 220 x 200 Universal Flange
9313S-M10	9303S-HM5C	197	150	16	Hydraulic motor stainless steel wet seal pump, ports: 1-1/2" NPT x 1-1/4" NPT
9313SU-M10	9303S-HM5C-U	197	150	16	Hydraulic motor stainless steel wet seal pump, ports: 220 x 200 Universal Flange
9313S-M16	9303S-HM3C	194	103	20	Hydraulic motor stainless steel wet seal pump, ports: 1-1/2" NPT x 1-1/4" NPT
9313SU-M16	9303S-HM3C-U	194	103	20	Hydraulic motor stainless steel wet seal pump, ports: 220 x 200 Universal Flange
9314C-M08	9306C-HM1C	227	132	14	Hydraulic motor cast iron wet seal pump, ports: 2" NPT x 1-1/2" NPT
9314CU-M08	9306C-HM1C-U	227	132	14	Hydraulic motor cast iron wet seal pump, ports: 220 x 220 Universal Flange
9314C-M10	9306C-HM5C	233	150	17	Hydraulic motor cast iron wet seal pump, ports: 2" NPT x 1-1/2" NPT
9314CU-M10	9306C-HM5C-U	233	150	17	Hydraulic motor cast iron wet seal pump, ports: 220 x 220 Universal Flange
9314C-M16	9306C-HM3C	232	138	24	Hydraulic motor cast iron wet seal pump, ports: 2" NPT x 1-1/2" NPT
9314CU-M16	9306C-HM3C-U	232	138	24	Hydraulic motor cast iron wet seal pump, ports: 220 x 220 Universal Flange
9314S-M08	9306S-HM1C	227	132	14	Hydraulic motor stainless steel wet seal pump, ports: 2" NPT x 1-1/2" NPT
9314SU-M08	9306S-HM1C-U	227	132	14	Hydraulic motor stainless steel wet seal pump, ports: 220 x 220 Universal Flange
9314S-M10	9306S-HM5C	233	150	17	Hydraulic motor stainless steel wet seal pump, ports: 2" NPT x 1-1/2" NPT
9314SU-M10	9306S-HM5C-U	233	150	17	Hydraulic motor stainless steel wet seal pump, ports: 220 x 220 Universal Flange
9314S-M16	9306S-HM3C	232	138	24	Hydraulic motor stainless steel wet seal pump, ports: 2" NPT x 1-1/2" NPT
9314SU-M16	9306S-HM3C-U	232	138	24	Hydraulic motor stainless steel wet seal pump, ports: 220 x 220 Universal Flange
9316C3U-M08	9306C-HM1C-3U	286	127	14	Hydraulic motor cast iron wet seal pump, ports: 300 x 220 Universal Flange
9316C3U-M10	9306C-HM5C-3U	311	150	18	Hydraulic motor cast iron wet seal pump, ports: 300 x 220 Universal Flange
9316C3U-M16	9306C-HM3C-3U	307	128	24	Hydraulic motor cast iron wet seal pump, ports: 300 x 220 Universal Flange
9316S3U-M08	9306S-HM1C-3U	286	127	14	Hydraulic motor stainless steel wet seal pump, ports: 300 x 220 Universal Flange
9316S3U-M10	9306S-HM5C-3U	311	150	18	Hydraulic motor stainless steel wet seal pump, ports: 300 x 220 Universal Flange
9316S3U-M16	9306S-HM3C-3U	307	128	24	Hydraulic motor stainless steel wet seal pump, ports: 300 x 220 Universal Flange

Case Drain motor available - Add suffix "Y" (i.e. 9316C3U-M08Y)

HYPRO® HYDRAULICALLY-DRIVEN, POLYPROPYLENE



9303P

Hypro Series 9300 Polypropylene, Hydraulic-Motor-Driven Models

Part #	Max GPM	Max PSI	Description
9303P-HM1C	110	130	13 GPM hydraulic motor/polypropylene pump for open/closed center systems, ports (NPT); 1 1/2" inlet, 1 1/4" outlet
9303P-HM4C	82	85	7 GPM hydraulic motor/polypropylene pump for open/closed center systems, ports (NPT); 1 1/2" inlet, 1 1/4" outlet
3430-0456			Vent line kit with 25' long, 1/4" ID vinyl hose, 1/8" NPT x 1/4" HB 90° nylon elbow fitting 1/8" NPT x 1/4" HB straight polypropylene fitting, plastic hose clamp and plastic cable tie
3430-0445			Seal and o-ring repair kit.

HYPRO® BELT-DRIVEN, PTO, CAST IRON



9400
Belt Drive

Hypro Series 9400 Cast Iron, Belt-Driven Models With 12-Groove Belt & Idler Pulley

Part #	Max GPM	Max PSI	Max RPM	Shaft	Pump Housing	NPT Ports
9402C-540	76	95	600	1 3/8" hollow, 6-spline	cast iron	1 1/4" inlet, 1" outlet
9403C-540Q	140	104	600	1 3/8", 6-spine quick coupler	cast iron	1 1/2" inlet, 1 1/4" outlet
9403C-540S	140	104	600	1" solid	cast iron	1 1/2" inlet, 1 1/4" outlet
9403C-1000	140	104	1000	1 3/8" hollow, 21-spline	cast iron	1 1/2" inlet, 1 1/4" outlet
3430-0332						Seal and o-ring repair kit for cast iron models.
3430-0333						Seal and o-ring repair kit for polypropylene models.
3430-0476						Seal, o-ring, belt and gasket repair kit for 540 rpm drives with cast iron pumps
3430-0477						Seal, o-ring, belt and gasket repair kit for 1000 rpm drives with cast iron pumps.
3430-0478						Seal, o-ring, belt and gasket repair kit for 540 rpm drives with polypropylene pumps.

HYPRO® AC MOTOR DRIVEN, POLYPROPYLENE



9940-9753NRL



9940-9750NRL

Hypro Series 9940-9700 AC Motor-Driven & Pedestal Mount Models

Part #	Max GPM	Max PSI	Max RPM	Description
9940-9750NRL	132	35	3600	Chemical-resistant Noryl, pedestal mount pump designed for direct drive with an electric motor or belt and pulley drive with an electric motor or gas engine. Carpenter 20 stainless steel 5/8" solid shaft. 1 1/2" NPT inlet; 1 1/2" outlet NPT ports.
9940-9753NRL	88	30	3450	Chemical-resistant Noryl pump close-coupled to a 1 1/2 hp, 115/208-230V AC motor. 1 1/2" NPT inlet, 1 1/2" NPT outlet ports.

To see our wide variety of nurse trailer models: [Nurse Trailer Line Card \(pdf\)](#).

HYPRO®

GAS ENGINE SPRAYER PUMPS



1521C-65



1552C-130

Hypro Series 1521C & 1552C Cast Iron, Gas Engine-Driven Power Pro™ Models

Part #	Max GPM	Max PSI	Description
1521C-65	110	80	1-1/2" x 1-1/4" Port Size, PowerPro™ 6.5hp
1538*			1-1/2" x 1-1/4" centrifugal pump. DOES NOT include engine.
3430-0332			Seal and o-ring repair kit
3430-0589			Life Guard® silicon carbide seal kit
1552C-130E	170	150	2" x 1-1/2" Port Size, PowerPro™ 13 hp with electric start
1551*			2" x 1-1/2" centrifugal pump kit. DOES NOT include engine.
1551-SP*			2" x 2" centrifugal pump kit. DOES NOT include engine.
1551-BSP*			2" x 2" centrifugal pump kit. (BSP threads) DOES NOT include engine.
3430-0464			Seal and o-ring repair kit.

*Must use threaded-shaft engine.

HYPRO®

GAS ENGINE-DRIVEN, CAST IRON



1550

Hypro Series 1550 Cast Iron, Gas Engine-Driven Models

Part #	Max GPM	Max PSI	Description
1550	150	140	2" X 1-1/2" Port. Includes Honda 9 Hp Engine
1551*			2" X 1-1/2" Centrifugal Pump Kit. DOES NOT INCLUDE ENGINE.
1551-SP*			2" X 2" Centrifugal Pump Kit. DOES NOT INCLUDE ENGINE.
3430-0464			Seal And O-Ring Repair Kit.

HYPRO®

GAS ENGINE-DRIVEN, CAST IRON AND POLY



1536/1539



1537

Hypro Series 1536, 1539, 1537 & 1540 Cast Iron, Gas Engine-Driven Models

Part #	Max GPM	Max PSI	Description
1536	110	75	1-1/2" x 1-1/4" Port Size, Briggs & Stratton 900 Series
1539-SP	100	65	Same as model 1536 without mounting base
1537	110	80	1-1/2" x 1-1/4" Port Size, Honda GX160
1540-SP	106	75	Same as model 1537-SP without mounting base
1538*			1-1/2" x 1-1/4" centrifugal pump kit. DOES NOT include engine.
1538-SP*			2" x 2" centrifugal pump kit. DOES NOT include engine.
9213P	91	65	1-1/2" x 1-1/4" Port Size, 4-3/4" Hollow keyed, 4-5HP Engine
3430-0332			Seal and o-ring repair kit
3430-0333			Seal and o-ring repair kit for 9213P
3430-0589			Life Guard® silicon carbide seal kit

*Must use threaded-shaft engine.

HYPRO® LOW PRESSURE DIAPHRAGM PUMPS



Hypro Low Pressure Diaphragm Pumps

Part #	Max GPM	Max PSI	Max RPM	Description
9910-D70	19	290	550	2 - diaphragm pump-1 1/4" HB inlet, 1" HB outlet. Select shaft kit for desired drive.
9910-D70GR	19	290	3600	2 - diaphragm pump - 3/4" hollow shaft with gear reduction for 5 HP gasoline engine
9910-D115	30.1	290	550	3 - diaphragm pump - 1 1/2" HB inlet, 1" HB outlet. Select shaft kit for desired drive.
9910-D135	34.8	290	550	3 - diaphragm pump - 1 1/2" HB inlet, 1" HB outlet. 1 3/8" - 6 splined male shaft.
9910-D160	42.5	290	550	4 - diaphragm pump - 2" HB inlet, 1 1/2" HB outlet. 1 3/8" - 6 splined male shaft.
9910-D250	66	290	550	6 - diaphragm pump - 2" HB inlet, 1 1/2" HB outlet. 1 3/8" - 6 splined male shaft.

HYPRO® MEDIUM PRESSURE DIAPHRAGM PUMPS



Hypro Medium Pressure Diaphragm Pumps

Part #	Max GPM	Max PSI	Max RPM	Description
9910-D252	6.1	363	650	2 - diaphragm pump - 3/4" HB inlet, 1/2" NPT outlet. D252 - 3/4" solid keyed shaft.
9910-D252GRGI	6.1	363	3600	2 - diaphragm (semi-hydraulic) pump - 3/4" HB inlet; 3/8" HB outlet. 3/4" hollow shaft, gear reduced for 2-3 1/2 HP gas engine & 9910-KIT1990 control unit.
9910-D30	9.0	580	550	2 - diaphragm pump - 1" HB inlet, 1/2" HB outlet.
9910-D30AP-A	9.0	580	550	Same pump as 9910-D30 with - 3/4" solid extended shaft. Select shaft kit with base or gear reduction.
9910-D30GRGI	9.0	580	3600	2 - diaphragm pump. assem. w/gearbox 9910-KIT1640 & control 9910-GR40 for mounting on 5 HP gas engine.
9910-D403GRGI	10.6	580	3600	3 - diaphragm pump. assem. w/gearbox 9910-KIT1640 & control 9910-GR40 for mounting on 5-6 HP gas engines.
9910-D50	14.0	580	550	2 - diaphragm pump. 1 1/4" HB inlet, 1/2" HB outlet.
9910-D50AP-A	14.0	580	550	Same pump as 9910-D35 with - solid thru shaft. Select shaft kit with base or gear reduction.
9910-D503	15.0	580	550	3 - diaphragm pump. 1 1/4" HB inlet, 3/4" NPT outlet. Select shaft kit or gearbox.
9910-D503GRGI	15.0	580	3600	3 - diaphragm pump. assem. w/gearbox 9910-KIT1642 & control 9910-RM40 for mounting on 8 hp gas engines.

HYPRO® HIGH PRESSURE DIAPHRAGM PUMPS



Hypro High Pressure Diaphragm Pumps

Part #	Max GPM	Max PSI	Max RPM	Description
9910-D1064	28.7	725	550	4 - diaphragm pump 1-1/4" HB inlet, 3/4" NPT outlet, 1-3/8"- 6 splined male shaft extension
9910-DBA140	37.8	725	550	3 - diaphragm pump. 1-1/2" HB inlet, 3/4" NPT outlet, 1-3/8"- 6 splined male double-ended shaft
9910-DBA160	39.6	725	550	4 - diaphragm pump. 1-1/2" HB inlet, 3/4" NPT outlet, 1-3/8"- 6 splined male double-ended shaft



HYPRO® MEDIUM PRESSURE DIAPHRAGM, GAS ENGINE-DRIVEN

Hypro Diaphragm Pump Gas Engine Units

Part #	Max GPM	Max PSI	Max RPM	Description
D403GRGI-65	10.6	580	3600	Model D403 diaphragm pump with GR40 control unit and KIT1640 gearbox, PowerPro 6.5 hp gas engine

HYPRO® DIAPHRAGM PUMP ACCESSORIES



9910-KIT1990



9910-GS40GI



9910-GH50



9910-HYD5312



9910-HYD1570



9910-HYD2495



9910-KIT1640



9910-KIT1642

Hypro Control Units for Pressure & Output Control of Sprayers

Part #	Max GPM	Max PSI	Description
9910-KIT1990	6.0	290	Control unit for mounting on 9910-D252 model pumps. Includes relief valve and pressure/bypass selector. 5/8" HB bypass port and 3/8" HB outlet.
9910-GS40GI	21	580	Control unit for Models 9910-D30 & D50. Includes pressure gauge, high pressure relief valve, complete bypass lever, two 1/2" HB outlets with individual shut-offs, and 3/4" HB bypass
9910-KIT1741			Remote mounting kit for 9910-GS40GI or 9910-GR40 control units. Includes mounting bracket, bolts, and hose barb.
9910-GH50	52.8	725	Control unit for 9910-DBS110, 9910-DBA110, DBS140, DBA140, DBS160, DBA160, DBS200 and DBA200. Includes: working pressure regulating valve, bypass control lever and glycerine-bath pressure gauge with colored dial.

Hypro Hydraulic Motor Mounting Flange Kit

Part #	Description	Mounts On
9910-HYD5312	Kit includes one flange with SAE "A" 2-bolt hydraulic motor mount, one 1" hollow shaft and hardware for mounting	9910-D30, D303, D403, D50, D503, D813, D1064 and D1265
9910-HYD1570	Kit includes one flange with SAE "A" 2-bolt hydraulic motor mount, one coupling and hardware for mounting. Hollow 1" shaft 1/4" keyed.	9910-D160 and D250
9910-HYD2495	Kit includes one flange with SAE "A" 2-bolt hydraulic motor mount, one coupling, two pins & spacer for D135. Hollow 1" shaft 1/4" keyed.	9910-D70, D115, D135, D160 and D250

Hypro Gear Reduction Kits

Part #	Description
9910-KIT1640	For Model 9910-D30, D303 and D403 pumps 6:1 gear box for standard 5.5 hp gas engine with 3/4" shaft.
9910-KIT1642	For Model 9910-D50, D503, D813, D1064 and D1265 pumps 6:1 gear box for standard 8-18 hp gas engine with 1" shaft.

SHURFLO®



Pressure Switch
5059-1310-D011

SHURFLO®



Bypass
5059-3611-D011

SHURFLO®



Bypass
8000-543-250

SHURFLO®



Pressure Switch
2088-343-135

Shurflo Diaphragm Pumps

Part #	Volts	Max GPM	Max Amp Draw	Type Of Control	Shut Off Pressure	Switch On Pressure	Port Size	Valve Material	Diaphragm Material
2087-593-135	12	3.0	8.0	Demand Switch	50 PSI	45 PSI	1/2" MPT	Viton	Santoprene
2088-343-135	12	3.0	7.7	Demand Switch	60 PSI	45 PSI	1/2" MPT	Viton	Santoprene
2088-443-144	12	3.5	9.1	Demand Switch	60 PSI	45 PSI	1/2" MPT	Santo	Santoprene
2088-514-144	12	4.0	12.0	Demand Switch	60 PSI	45 PSI	1/2" MPT	Santo	Santoprene
2088-313-145	12	3.6	9.5	Demand Switch	60 PSI	45 PSI	1/2" MPT	Viton	Santoprene
2088-394-154	115-AC	3.2	0.9	Demand Switch	40 PSI	20 PSI	1/2" MPT	Viton	Santoprene
5059-1310-D011	12	5.3	17.0	Demand Switch	60 PSI	PSI	1/2" NPTF	Viton	Santoprene
5059-1311-D011	12	5.3	17.0	Demand Switch	60 PSI	PSI	1/2" NPSM	Viton	Santoprene
5059-3610-D011	12	5.3	20.9	Internal BP	80 PSI	Bypass	1/2" NPTF	Viton	Santoprene
5059-3611-D011	12	5.3	20.9	Internal BP	80 PSI	Bypass	1/2" NPSM	Viton	Santoprene
8000-533-250	115-AC	1.4	0.7	45 PSI internal BP	Bypass	Bypass	3/8" FPT	Viton	Santoprene
8000-533-236	115-AC	1.4	0.7	Demand Switch	60 PSI	45 PSI	3/8" FPT	Viton	Santoprene
8000-543-236	12	1.4	7.0	Demand Switch	60 PSI	45 PSI	3/8" FPT	Viton	Santoprene
8000-543-936	12	1.8	7.0	Demand Switch	60 PSI	45 PSI	3/8" FPT	Viton	Santoprene
8000-643-236	12	1.8	7.0	Demand Switch	60 PSI	45 PSI	3/8" FPT	Buna	Geolast
8000-543-250	12	1.4	5.0	45 PSI Internal BP	Bypass	Bypass	3/8" FPT	Viton	Santoprene
8000-543-220	12	1.5	7.1	Internal BP	Bypass	Bypass	3/8" FPT	Viton	Santoprene
8007-593-836	12	1.8	7.0	Demand Switch	60 PSI	45 PSI	3/8" FPT	Viton	Santoprene
8007-594-838	12	2.1	7.0	Demand Switch	100 PSI	50 PSI	3/8" FPT	Viton	Santoprene

SHURFLO POWER TWIN FLOWS TO 7 GPM



SHURFLO®

Pressure (PSI) Inlet/Outlet	Flow (GPM)	Current (AMPS)
0/2	6.82	9.54
10	6.22	11.80
20	5.64	14.46
30	5.02	17.14
40	4.35	18.98

Power Twin Double-Headed Pump 12 VDC with Heat Sink, Viton Valves, Santoprene Diaphragms, Splash-Proof Demand Switch, 45 PSI, 3/4" Manifold, 1/2" MPT Inlet and Outlet.

Part #
4311-035

HIGH-FLO HIGH PERFORMANCE 12 VOLT DIAPHRAGM PUMPS

HIGHFLO
HIGH PERFORMANCE



1.2 GPM (5151086)

HIGHFLO
HIGH PERFORMANCE



2.4 GPM (5151087)

HIGHFLO
HIGH PERFORMANCE



4.5 GPM (5151088)

Part #	Volts	Amps	Demand Switch Or Relief Valve	Max Pressure	Gallons Per Minute Max
5151086	12	4.0	Demand Switch	60	1.2
5151087	12	8.0	Demand Switch	60	2.4
5151088	12	14.0	Demand Switch	60	4.5

OZAWA METERING PUMPS



- Up to four independent pump heads
- High Chemical Resistance
- Accurate and Reliable
- Low Maintenance
- Easy Operation

Ozawa R&D Inc.
ADVANCED WATER PRODUCTS

Part #	Description
10260	1 HD A.C. 60-3ZB
22760	2 HD A.C. 90-3ZB
2302	Head Assembly 3ZB

NEPTUNE FERTILIZER PUMPS



- Series 500 Hydraulic Diaphragm Metering Pumps
- Bi-Directional Motor
- Teflon diaphragm and Viton O-ring
- 316SS wetted metal parts
- Available with 30, 65, 80 GPH systems

Neptune
CHEMICAL PUMP CO., INC.

Part #	Description
547-VS-N3T	NEPTUNE PUMP, SIMPLEX-29-GPH
565-S-N3T	NEPTUNE PUMP, SIMPLEX-65-GPH
567-S-N3T	NEPTUNE PUMP, SIMPLEX-80-GPH
EFP-1	Base

BLUE-WHITE FLOW METERS

Part #	Description
F-40500LN-8	0.5 to 5.0 GPM Adapter FPT 1/2" Polypropylene 316SS
F-40750LN-12	1 to 10 GPM Adapter FPT 1/2" Polypropylene 316SS
F-41017LN-12	1 to 17 GPM Adapter FPT 3/4" Polypropylene 316SS
F-41000LN-12	2 to 20 GPM Adapter FPT 3/4" Polypropylene 316SS

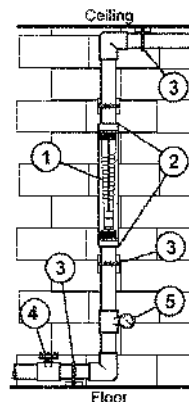

- Durable, highly polished, one piece meter body.
- Annealed for added strength and chemical resistance.
- Acceptable for outdoor installations (acceptable in direct sunlight)
- Direct reading permanent scale.
- White back reflector for easy reading.
- Standard 316 stainless floats and guide rods, optional Hastelloy-C for more corrosive environments.

F-40500LN-8 F-41000LN-12



POLY SELF-PRIMING CENTRIFUGAL PUMP



200PH5



200P6PRO



300PH6

BANJO POLY PUMP (GAS ENGINE PUMP WITH EPDM RUBBER PARTS)

<u>Part #</u>	<u>Size</u>	<u>Model</u>	<u>GPM</u>
150P3	1 1/2"	800 Series Briggs	100
200P3	2"	800 Series Briggs	100
200P6PRO	2"	950 Series Briggs	160
200PH5	2"	GX160 Honda	160
300PH6	3"	GX200 Honda	300
300P11PRO	3"	1650 Series Briggs	320

BANJO POLY BEARING PEDESTAL PUMP (TO ADAPT TO ELECTRIC ENGINE)

<u>Part #</u>	<u>Description</u>
200PB	2" pump/ pedestal 3/4" shaft
300PB	3" pump/ pedestal 3/4" shaft
205PB	2" pump/ pedestal 3/4" shaft
12882A	Bearing pedestal 3/4" shaft

BANJO POLY PUMPS WITH VITON RUBBER PARTS

<u>Part #</u>	<u>Size</u>	<u>Model</u>	<u>GPM</u>
200P6PROV	2"	950 Series Briggs	160
200PH5V	2"	GX160	160

BANJO POLY BEARING PEDESTAL PUMP WITH VITON PARTS

BANJO POLY PUMP ONLY WITH VITON PARTS

<u>Part #</u>	<u>Description</u>
200POV	2" pump only w/ Viton parts
200PO	2" pump only
M225PO	2" poly manifold pump only 5 vane imp 3/4 shaft
205POV	2" pump only w/ Viton parts
205PO	2" pump only

333 SERIES PUMP



<u>Part #</u>	<u>Description</u>
333PBI	3" CI Pump/bearing pedestal with a 1" keyed shaft



444 SERIES PUMP



Graphite loaded silicon carbide seal with stainless steel cup and spring with FKM (viton type) rubber

<u>Part #</u>	<u>Description</u>
444PIH24	4" CI Pump, with 24 h.p. Honda Engine



FRANKLIN TRANSFER PUMPS

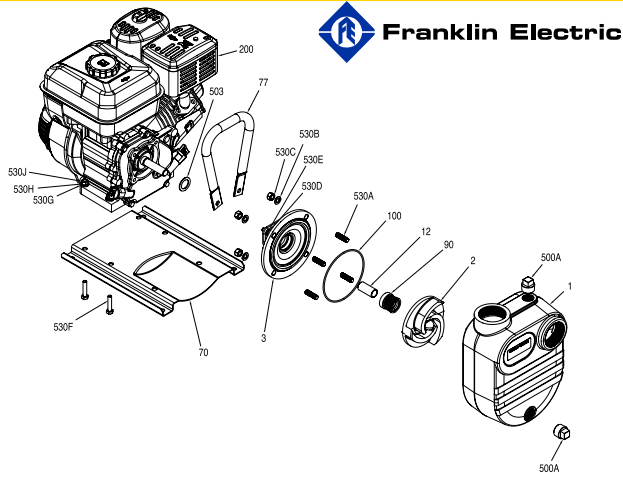

Fig. No.	Part Description	Part No.						Materials of Construction		
		FBSGF-8	FBSGF-8H	FBSGF-10	FBSGF-10H	FBSDF-10RF	FBSGF-12		FBSGF-12H	
1	Pump Case			305460001			305460002	Cast Iron, ASTM-A48 CL30		
2	Impeller	305460003		305460004			305460005	Cast Iron, ASTM-A48 CL30		
3	Motor Adapter			305460007			305460008	Cast Iron, ASTM-A48 CL30		
12	Mech Seal Shaft Sleeve			305458010			305458011	416 Stainless steel		
70	Base, Engine Frame	305459015			n/a		305459016	CRS		
Not Shown	Roll Frame	n/a		305458013			n/a	CRS		
77	Pump Handle	305460009	305460010	305460009	n/a	305460021	305460011	CRS		
90	Mechanical Shaft Seal	305463116					305463043	Carbon/ Ceramic/Iron/316SS		
100	Case O-Ring	305463125					305463126	EPDM		
200	Engine	See Engines Below						Misc.		
500A	Pipe Plug	305463050						Cad-Plated Steel		
503	Water Slinger	305460012		305458022	305460024		305456009	Neoprene		
530A	Stud - Volute (4 Req)	305463129						Zinc Plated Steel		
530B	Lockwasher - Volute (8-Pack)	305463032						Zinc Plated Steel		
530C	Hex Nut - Volute (8-Pack)	305463033						Zinc Plated Steel		
530D	Hex Bolt - Bracket	305463128			305463121		305463189	Zinc Plated Steel		
530E	Int. Lockwasher - Bracket (4-Pack)	305463127					305463190	Zinc Plated Steel		
530F	Hex Bolt - base	305463122					305463191	305463122	Zinc Plated Steel	
530G	Flat Washer - Base (4-Pack)	305463109						Zinc Plated Steel		
530H	Lockwasher-Base	305463092						Zinc Plated Steel		
530J	Hex Nut - Base	305463062						Zinc Plated Steel		
Not Shown	Spacer (4-Pack)	n/a						305463192	n/a	Cast Iron, ASTM-A48 CL30

NOTE: The B/S p/n has changed in the engine table.
Viton® is a registered trademark of E. I. du Pont de Nemours and Company.

HYPRO®

HYPRO 2" & 3" POLY AND ALUMINUM TRANSFER PUMPS



1542P-65SPM



1572-SPX

Part #	Max GPM	Max PSI	Port Size	Description
1542P-65SPM	200	58	2" x 2"	PowerPro™ 6.5 hp
1542P-65SP	200	58	2" x 2"	PowerPro™ 6.5 hp
1572-SPX	145	50	2" x 2"	Honda GX120
1573-SPX	280	50	3" x 3"	Honda GX160
3430-0792				2" Transfer Kit (NPT ports, SAE 3/4" keyed shaft mount)
3430-0793				3" Transfer Kit (NPT ports, SAE 3/4" keyed shaft mount)

HYPRO® 3" POLYPROPYLENE TRANSFER PUMPS

- Gas engine mount, pedestal mount or hydraulic drive options available
- Gas engine-driven versions powered by field proven 13 HP Hypro PowerPro™ engine or Honda GX390
- Housing: 3" X 3" Polypropylene
- Pump Seals: EPDM Mechanical
- Suction lift: 25 ft./7.62m
- Poly impeller with stainless steel insert

440 GPM

GPM AT 0 PSI	GPM AT 10 PSI	GPM AT 20 PSI	GPM AT 30 PSI	GPM AT 40 PSI	GPM AT 50 PSI	GPM AT 54 PSI
440	400	338	269	184	68	0



1542P-65SP



1543P-130ESP-01

Hypro 3" Polypropylene Transfer Pumps

Part #	Max GPM	Max PSI	Port Size	Description
1543P-130ESP	440	54	3" x 3"	PowerPro 13 HP with elec. start
1543P-130ESP-01	440	54	3" x 3"	PowerPro 13 HP with elec. start and flange fittings
1543P-390EHSP	440	54	3" x 3"	Honda® GX390 with elec. start
9343P-GM6Y-SP*	450	52	3" x 3"	Hydraulic
9343P-GM10-SP	484	58	3" x 3"	Hydraulic
3430-0692				Pump head kit with EPDM seal
3430-0757				EDPM seal kit (4) O-Rings; (1) Mechanical Seal O-Ring; (1) Mechanical Seal; (1) Impeller O-Ring; (1) Flapper; (1) Body O-Ring

TRANSFER PUMPS

BSEF SERIES

These Monarch close coupled electric motor driven, utility pumps have a large rugged casing for fast self priming. The BSEF series feature cast iron construction, with a Viton shaft seal and down-sized impeller, to handle heavier ag chemical pumping applications

Part #	HP	Suct NPT	Disch. NPT	Electrical Characteristics
BSEF-150TE	1 1/2	1 1/4"	1 1/4"	1/60/230V, TEFC motor
BSEF-200TE	2	2"	2"	1/60/230V, TEFC motor
BSEF-300TE	3	2"	2"	1/60/230V, TEFC motor
BSEF-300-3TE	3	2"	2"	3/60/230/460V, TEFC motor
BSEF-500TE	5	3"	3"	1/60/230/460V, TEFC motor



ENGINE DRIVEN SELF PRIMING - BSGF SERIES WITH IRON CLAD

BSGF SERIES - GASOLINE ENGINE DRIVEN - GENERAL PURPOSE LIQUID TRANSFER

Part #	Suct & Disch. NPT	Model	Electrical Description
BSGF-10	2" x 2"	900 Series	B&S standard, with 3 qt. fuel tank.
BSGF-10HONDA		GX160	Honda, with 4 qt. fuel tank.
8BSGF-12	3" x 3"	1550 Series	B&S standard, with 4 qt. fuel tank.
8BSGF-12HONDA		GX270	Honda, with 6 qt. fuel tank.



2 Year Pump End Warranty

FUEL TRANSFER PUMPS

FUEL TRANSFER PUMPS



12 VOLT

- 18 GPM
- Spin Collar
- 12 ft. of 1" hose
- Automatic Nozzle
- Adjustable Suction Pipe
- 15 ft. Power Cord

Part #

M-180S-AU

** Above 2 models come with a 2 year warranty **

FILL-RITE FUEL METERS



- 3 Wheel Mechanical Meter
- 1" Meter
- 5 - 20 GPM
- Nickel

Part #

807CN1



- 4 Wheel Mechanical Meter
- 1.5" Meter
- 6 - 40 GPM
- Nickel

Part #

901N1.5

2" CAST IRON, WET SEAL TRANSFER PUMP

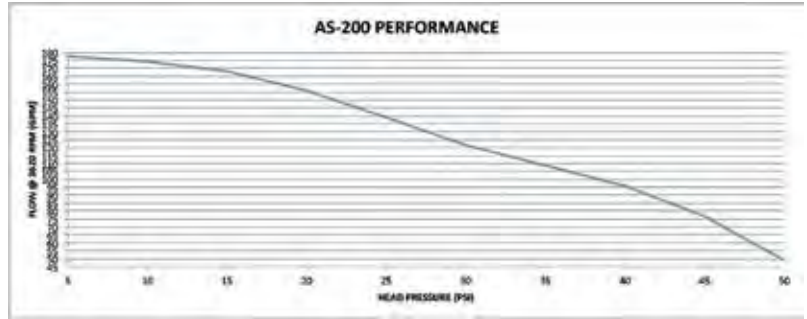

Part #	Description
AS-200U	2" Wet Seal Pump Only, Self-Priming, 3/4" Shaft
AS-200U-G5.5H-KIT	2" Wet Seal Pump With GX160 Honda

- Cast Iron Housing And Impeller Designed For Rugged Applications
- Wet Seal Reservoir Designed To Allow Seals To Run Consistently In Liquid
- Honda GX160
- High Flow 178 GPM @ 5 PSI
- 2" FNPT Inlet & Outlet
- 1/2" Drain Plug
- 2 Year Unconditional Warranty

3" CAST IRON, WET SEAL TRANSFER PUMP

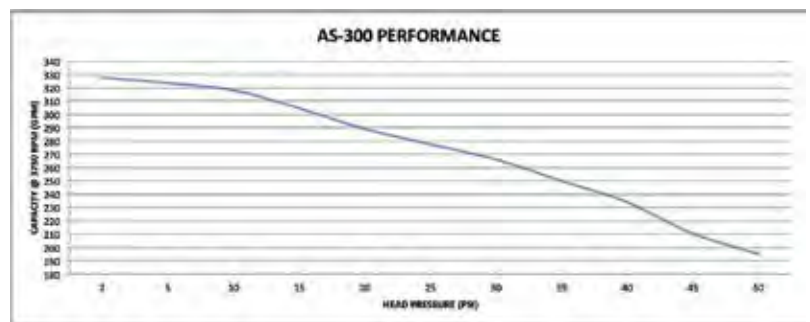

Part #	Description
AS-300U	3" Wet Seal Pump Only, Self-Priming, 1" Shaft
AS-300U-G13HES-KIT	3" Wet Seal Pump With GX390 Honda Electric Start

- Cast Iron Housing And Impeller Designed For Rugged Applications
- Wet Seal Reservoir Designed To Allow Seals To Run Consistently In Liquid
- Honda GX390 With Electric Start
- High Flow 332 GPM @ 0 PSI
- 3" FNPT Inlet & Outlet
- 1/2" Drain Plug
- 2 Year Unconditional Warranty

ELECTRIC CAST IRON, WEST SEAL TRANSFER PUMP

ELECTRIC 2" CAST IRON, WET SEAL TRANSFER PUMP



- *Cast Iron Housing And Impeller Designed For Rugged Applications*
- *Wet Seal Reservoir Designed To Allow Seals To Run Consistently In Liquid*
- *5 HP 1 Phase / 3 Phase Electric Motor*
- *High Flow 160 GPM @ 0 PSI*
- *2" FNPT Inlet & Outlet*
- *1/2" Drain Plug*
- *2 Year Unconditional Warranty*

Part #

Description

AS-2005HP1-KIT

2" Wet Seal Pump With 5 HP 1 Phase Electric Motor

AS-2005HP3-KIT

2" Wet Seal Pump With 5 HP 3 Phase Electric Motor

ELECTRIC 3" CAST IRON, WET SEAL TRANSFER PUMP



- *Cast Iron Housing And Impeller Designed For Rugged Applications*
- *Wet Seal Reservoir Designed To Allow Seals To Run Consistently In Liquid*
- *10 HP 1 Phase / 3 Phase Electric Motor*
- *High Flow 332 GPM @ 0 PSI*
- *3" FNPT Inlet & Outlet*
- *1/2" Drain Plug*
- *2 Year Unconditional Warranty*

Part #

Description

AS-30010HP1-KIT

3" Wet Seal Pump With 10 HP 1 Phase Electric Motor

AS-30010HP3-KIT

3" Wet Seal Pump With 10 HP 3 Phase Electric Motor

CDS-JOHN BLUE SQUEEZE PUMPS

Standard Pumps with Lubricated Nylon Bearings

Part #	# of Hoses	Metering Hose Size	GPA Rating	Discharge Hose Size	Suction Hose Size
L-6-C	6	1/2"	HIGH (7-45)	1/2"	1"
L-8-C	8	5/16"	LOW (3-18)	3/8"	1"
L-8-LC	8	1/2"	HIGH (7-45)	1/2"	1 1/4"
L-12-SC	12	5/16"	LOW (3-18)	3/8"	1 1/4"
L-12-C	12	1/2"	HIGH (7-45)	1/2"	1 1/4"
L-16-C	16	5/16"	LOW (3-18)	3/8"	1 1/4"



L-6-C

Optional Accessories

Part #	Description
L-4513	Sprocket Package - Complete; Includes L-1414 & L-4414; 8T, 9T, 10T, 15T, 22T, 23T, 26T, 30T, & 31T Sprockets

John Blue Replacement Hoses

Part #	Description
87249	1/2" Squeeze pump hose
87250	5/16" Squeeze pump hose

Miscellaneous Components

Part #	Description
L-1414	Sprocket Adaptor - 7/8" Bore
L-1414-1	Sprocket Adaptor - 1" Bore
L-1414-2	Sprocket Adaptor - 3/4" Bore
L-4414	Sprocket Retainer - 7/8" Bore
L-4414-1	Sprocket Retainer - 1" Bore
L-4414-2	Sprocket Retainer - 3/4" Bore
112838	Sprocket Retainer - 7/8" Hex
112839	Sprocket Adaptor - 7/8" Hex
114936-91	Split Sprocket - 7/8" Hex; 32 Tooth

Miscellaneous Components

Part #	Description
L-1383	8 Tooth Sprocket
L-1384	9 Tooth Sprocket
L-1385	10 Tooth Sprocket
L-1386	15 Tooth Sprocket
L-1381	20 Tooth Sprocket
L-1387	22 Tooth Sprocket
L-1388	23 Tooth Sprocket
L-1389	26 Tooth Sprocket
L-1390	30 Tooth Sprocket
L-1391	31 Tooth Sprocket
L-1392	32 Tooth Sprocket

NGP LIQUID METERING PUMP



Part #	Description
DRV-3200	Piston Pump Mounting Kit
DRV-3300	Universal Pump Spring Load Ground Drive



Part #	Description	Max GPM	Inlet / Outlet
NGP-4055-F	Single Piston	10.26	1" FPT x 1" FPT
NGP-6055	Single Piston	21.0	1 1/2" FPT x 1 1/2" FPT
NGP-6055-S	Single Piston, Stainless Steel	21.0	1 1/2" FPT x 1 1/2" FPT
NGP-7055-S	Single Piston, Stainless Steel	34.2	1 1/2" FPT x 1 1/2" FPT
NGP-8055	Double Piston	42.0	1 1/2" FPT x 1 1/2" FPT
NGP-8055-S	Double Piston, Stainless Steel	42.0	1 1/2" FPT x 1 1/2" FPT
NGP-9055-S	Double Piston, Stainless Steel	68.4	1 1/2" FPT x 1 1/2" FPT
NGP-9055-DR	Double Piston - Less Manifold	68.4	(2) 1 1/2" FPT x (2) 1 1/2" FPT

IRRIGATION INJECTION PUMP

DOSTEC PISTON PUMP

Dostec-40

- Three phase motor
- Available 32 GPH, 64 GPH or 95 GPH

Dostec-40 Shown
w/ Pump Stand



Part #	Description
60-AP44-P34CBM	Dostec 32 GPH 3ph
60-AP44-P49CBM	Dostec 64 GPH 3 ph
60-AP44-P61CBM	Dostec 95 GPH 3 ph
PUMP STAND	
5281408-CBK	Dostec-40 Series Pump Stand

ADVANTAGES:

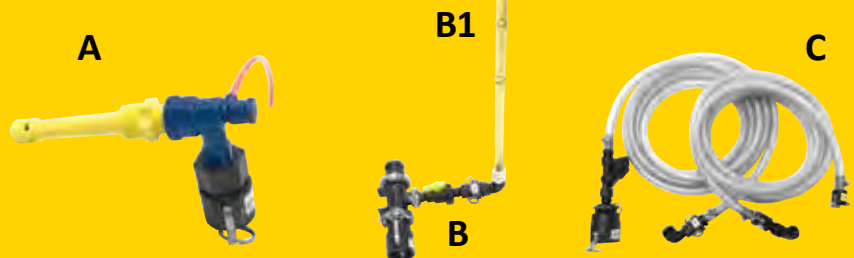
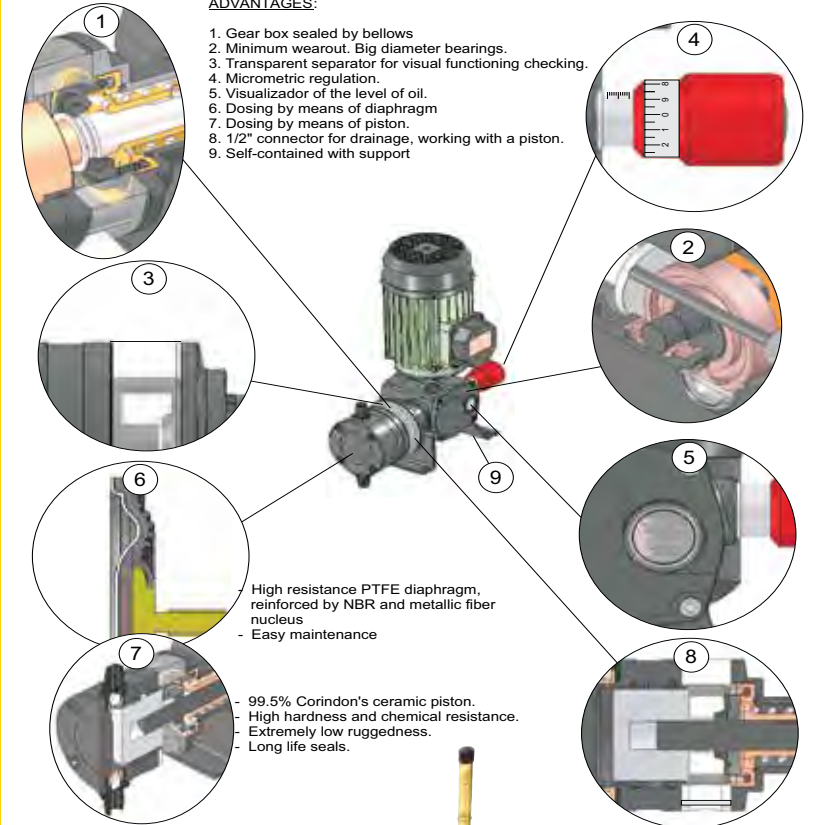

INJECTION PUMP ACCESSORY KITS

Ref #	Part #	Description
A	SHP-MRMRVL110-KIT	MRMRVL 3 to 110 GPH check valve & bleeder valve kit
B	SHP-IN-CAL48-KIT	Injection 48" calibration tube kit for tank w/ inline quick couplers
B1	822-13-048000-0	48" calibration tube assembly only w-3/4" male quick coupler inlet
C	SHP-INJ-HOSE-KIT	Injection Pump hose kit includes: Pump fittings, strainer and quick couplers



BLUMHARDT **PLANTER-TUBEHOLDERS**



45047 - JD 1700 Series Max Emerge w/Central Commodity Hopper, Also JD XP



45188 - JD 1700 Series MaxEmerge Plus w/Individual Seed Boxes (Back Coulter), Also JD XP Planter



45493 - JD 7000 & 7100 Series MaxEmerge
45493 - Kinze 300-3700 Series Planter



45184 - White 8000 Series Planters



45499 - White 5100 Series Planter



45494 - JD 7200 & 7300 Series MaxEmerge



64270 - White 6000 Series Planters



45488 - Crustbuster Planters



55574 - Case IH 800, 900, 955, 1200 Series Early Riser

Other Planter tubeholders not pictured: 45400 - JD 1200 Plateless Planter, Case IH 400 Cyclo Air Planter

* Most tubeholders are available in stainless steel. Add SS after part number.

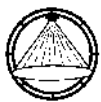

BLUMHARDT **DRILL-TUBEHOLDERS**



50203 - JD 1560, 1860 Series Air Drill (Right Side)



50185 - JD 1590, 1690, 1890, 1895 Air Drill (Right Side) *Available InStainless Steel Only 50186 - JD 1590, 1690, 1890, 1895 Air Drill (Left Side) *Available In Stainless Steel Only



45143 - JD 1520, 455 Double Disc, 730 Air Disc Drill



53187 - Great Plains Double Disc w/Seed Loc Shoe & 6" Pack Wheel



45468 - Case IH Double Disc 1976 & Newer, 510, 5100, 620, 6200 Series



45052 - Case IH 5400, 5500 Mulch Till Drill



45488 - Crust Buster Min. Till, All Till, No Till Double Disc



49723 - JD 750 Series No-Till Drill (Right Side)
50031 - JD 750 Series No-Till Drill (Left Side)



45188 - JD 1530, 15335 Series Tru-V Drive (Back Coulter)

Other Planter tubeholders not pictured: 45466 - Terra & Morris Double Disc

PRESSURE GAUGEES - SPRAYER, PRESSURE WASH & HYDRAULIC

QUANTITY DISCOUNTS WILL BE GIVEN ON VOLUME GAUGE ORDERS

SERIES WGG-SS LIQUID FILLED GAUGE

304 stainless steel case and tube, stainless steel stem and internals, black enameled aluminum pointer, polycarbonate window, liquid filled, built-in restrictor.

Stainless Steel Case / Stainless Steel Stem



Part #	Size	PSI
WGGSS60	2 1/2"	0-60
WGGSS100	2 1/2"	0-100
WGGSS160	2 1/2"	0-160
WGGSS400	2 1/2"	0-400
WGGSS604	4"	0-60
WGGSS1604	4"	0-160

SERIES GG LIQUID FILLED GAUGE

304 stainless steel case, bronze tube, brass stem and internals, white enameled aluminum dial face, black enameled aluminum pointer, acrylic window, liquid filled, built-in restrictor.

Stainless Steel case / 1/4" bottom brass stem

Part #	Size	PSI
GG60	2 1/2"	0-60
GG100	2 1/2"	0-100
GG604	4"	0-60
GG1004	4"	0-100



GAUGE DAMPENER

Part #	Size
DAMPENER	1/4"



CHEMICAL ISOLATOR KIT

The Chemical Isolator Kit keeps chemicals from entering the tractor cab for added operator safety and longer life on gauges and monitors. Dampens and protects pressure gauge from corrosive chemicals. Large capacity assures accurate pressure reading. Maximum operating pressure, 150 PSI. Pre-filled at the factory with non-toxic RV antifreeze.



Part #	Description
2300	Kit w/ mtg brkt, 1/8" & 1/4" fittings
2350	Kit w/ mtg brkt, 1/8" fpt less tube fts
2391	Kit w/ mtg brkt, 1/4" fpt less tube fts

SERIES ASG AMMONIA GAUGE

Enameled steel case, 304 stainless steel tube, stem and internals, coated aluminum dial face, black enameled steel pointer, polycarbonate window, 304 stainless steel stem with zinc dihydrogen phosphate plating, restrictor.

Stainless Steel 1/4" Bottom Stem

Part #	Size	PSI
ASG60	2 1/2"	0-60
ASG160	2 1/2"	0-160
ASG400	2 1/2"	0-400
ASG604	4"	0-60
ASG1604	4"	0-160



SERIES SG STANDARD DRY GAUGE

ABS plastic case, bronze tube, brass stem and internals, coated aluminum dial face, black enameled steel pointer, acrylic window, restrictor.

Dry Gauge / 1/4" Bottom Brass Stem

Part #	Size	PSI
SG60	2 1/2"	0-60
SG100	2 1/2"	0-100
SG160	2 1/2"	0-160
SG200	2 1/2"	0-200
SG604	4"	0-60
SG1004	4"	0-100



SERIES G STANDARD DRY GAUGE

Dry gauge / 1/4" bottom brass stem

Part #	Size	PSI
3-G	2"	0-60
5-G	2"	0-100
2-G	2"	0-400



PRESSURE GAUGE TUBING & FITTINGS



Part #	Description
5153059	1/8" OD Pressure Tubing
1181	Compression Fitting 1/8" MPT Tubing Connector
1182	Union Fitting 1/8" Tubing
214-0001-001	1/4" OD Pressure Tubing
333-0001-007	1/4" MPT X 1/4" Pressure Line Conn
333-0001-008	1/4" Pressure Line Union

SPEEDFIT 3-WAY VALVE

Part #	Size
MC-3-1/4	1/4"
MC-3-3/8	3/8"



REDBALL® FLOW MONITORS

Part #	Description
3999-0041	4 Column Assembly; (1) 3/4" HB in, (4) 1/4" OD Push to Connect outlets
3999-0042	4 Column Assembly; (1) 3/4" HB in, (4) 5/16" OD Push to Connect outlets
3999-0043	4 Column Assembly; (1) 3/4" HB in, (4) 3/8" OD Push to Connect outlets



4 Column Manifold Models(4 Column Units)

Part #	Description
3999-0001	4 Column Assmb; (1) 3/4" HB In, (4) 1/4" HB Out
3999-0002	4 Column Assmb; (1) 3/4" HB In, (4) 3/8" HB Out
3999-0008	4 Column Assmb; (1) 3/4" HB In, (4) 1/2" HB Out



1 Column Starter Models (Single Column Units)

Part #	Description
3999-3414	Monitor; 1/4" Starter, 3/4" HB In, 1/4" HB Out
3999-3438	Monitor; 3/8" Starter, 3/4" HB In, 3/8" HB Out
3999-3412	Monitor; 1/2" Starter, 3/4" HB In, 1/2" HB Out

1 Column Adder Models (Single Column Units)

Part #	Description
3999-0014	Monitor; 1/4" Adder, 1/4" HB Out
3999-0038	Monitor; 3/8" Adder, 3/8" HB Out
3999-0012	Monitor; 1/2" Adder, 1/2" HB Out

1 Column Squeeze Pump Models

Part #	Description
3999-1414	Monitor; 1/4" Squeeze, 1/4" HB In, 1/4" HB Out
3999-3838	Monitor; 3/8" Squeeze, 3/8" HB In, 3/8" HB Out
3999-1212	Monitor; 1/2" Squeeze, 1/2" HB In, 1/2" HB Out

SPRAY MONITOR REPLACEMENT PARTS SNAP-RING STYLE

Ref #	Part #	Description
1H	002133	1/4" Elbow Hose Barb
	002134	3/8" Elbow Hose Barb
	002135	1/2" Elbow Hose Barb
1P	20516	1/4" OD Push to Connect Elbow 90
	20528	5/16" OD Push to connect Elbow 90
	20517	3/8" OD Push to Connect Elbow 90
2	002140	O-Ring EPDM
	002141	O-Ring Viton
3	002137	Float Stop
4	8165105	Ball, Red Glass
	8165101	Ball, Green Plastic
	8165102	Ball, Black Plastic
	8165100	Ball, Red Plastic
	SS316-200	Ball, Stainless Steel
5	002037	U-Pin
6	002139	Column, Single
7	002138	Cap, Plug
8	002136	3/4" Elbow Hose Barb, Inlet
8a	20525	Connection Tee O-Ring x O-Ring x 1" FPT
1a	20518-00	1/4" FPT, 90°
1b	20519-01	1/4" FPT

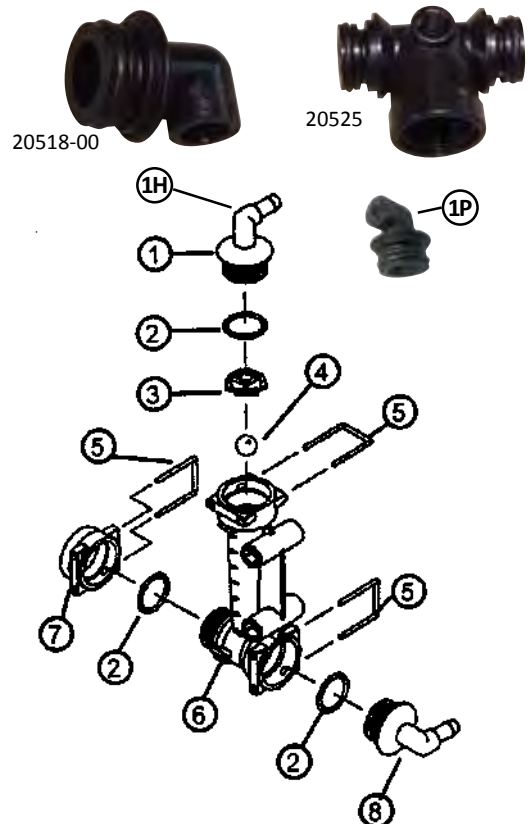

STS INDUCTOR SYSTEM



The STS (SMART TRANSFER SYSTEM) is designed to make adding chemical and surfactants quick and easy to your application equipment. Offered in 40 or 65 gallons with the option of 2" or 3" plumbing. The tank is designed with a molded 2" outlet for 100% drainage, eliminating any raised lip or flange that holds chemical residue. Control Handles positioned at ergonomic working height allow the operator to function the valves while never having to reach down under the tank. Standard with a 16" hinged lid and tank rinse plumbing make inducting chemicals fast and easy. Optional jug rinse kits available, whether you want a jug piercing cutting blade or rotating rinse nozzle assembly. The 4 legged welded stand is stout enough to mount the STS inductor system on a truck and stably enough to set on the ground.

STANDARD FEATURES

- 16" hinged lid
- Blue tank
- Tank rinse with valve
- Anti-vortex blade
- 4-leg stand
- "Toilet Bowl" tank rinse
- Valve handle linkage system for tank 2" outlet valve
- Eductor units - Bypass valve control lever
- Eductor plumbing can be reversed for left or right hand flow



Item #	MFG #	Description
5281637	STS-40	40 gallon tank and stand with outlet valve and valve control handle
5281633	STS-402E	40 gallon tank and stand with 2" eductor system with control handles
5281634	STS-403E	40 gallon tank and stand with 3" eductor system with control handles
5281638	STS-65	65 gallon tank and stand with outlet valve and valve control handle
5281635	STS-652E	65 gallon tank and stand with 2" eductor system with control handles
5281636	STS-653E	65 gallon tank and stand with 3" eductor system with control handles

JUG RINSE OPTIONS



Optional jug rinse kits available.

Simply remove the lid screws and drop in the jug rinse kit that meets your application needs. Whether you want a rotating rinse nozzle assembly, a jug slicer knife or jug piercing cutting blade to puncher and rinse.

Kit Includes: Jug rinse insert, plumbing for inside tank and 3/4" ball valve and fittings with 5' of 3/4" hose.



EZJR-16-STS-KIT



STS-SLICER-KIT



STS-JUG-PUNCHER-KIT

Item #	MFG #	Description
5281703	STS-JUG-RINSE-KIT	Jug rinse insert kit
5281702	STS-SLICER-KIT	Slicer jug rinse kit
5281704	STS-JUG-PUNCHER-KIT	4-Blade jug cutting puncher rinse kit

INDUCTOR / EDUCTOR SYSTEMS

MIX-N-FILL UNITS - FULL DRAIN CAPABILITY



15 GALLON
W/8" LID



35 GALLON
W/8" LID



35 GALLON
W/16" LID



60 GALLON
W/16" LID

Part #	Description
15IND-KIT	15 gal. inductor tank & stand / 8" lid
35IND-KIT	35 gal. inductor tank & stand / 8" lid

Part #	Description
35IND16-KIT	35 gal. inductor tank & stand / 16" lid
60IND-KIT	60 gal. inductor tank & stand / 16" lid

MIX-N-FILL UNITS

Complete with mounting plate and bolts for attaching to 6" or 7" channel trailer frames



Part #	Description
NT35IND-KIT	35 Gallon inductor tank and stand with 8" lid
NT35IND16-KIT	35 Gallon inductor tank and stand with 16" lid

2" & 3" POLY INDUCTOR SYSTEM

2" or 3" Venturi Inductor system, install after pump (Pressure side of pump). Completely empties inductor tank.



Part #	Description
MIS220HBAK	2" Venturi Inductor Kit 2" Hosebarb Inlet X 2" Male Camlock Outlet X 2" Mpt Product Valve W/ 2" Full-Port Bypass
MIS300A	3" Venturi Inductor Kit 3" Flange Inlet X 3" Male Camlock Outlet X 2" Mpt Product Valve W/ 3" Full-Port Bypass

2" POLY INDUCTOR SYSTEM WITH TANK RINSE

2" Poly Inductor System With Tank Rinse, Inlet 2" Hose Barb, Outlet 2" Male Quick Adapter

TANK & STAND NOT INCLUDED IN PRICE



Part #	Description
MIS220HBAK-RNS-KIT	Venturi W/Rinse Kit

2" INDUCTOR PLUMBING KIT FOR SUCTION SIDE OF PUMP

2" Chemical Inductor Plumbing Kit, install before pump (Suction side of pump).



Part #	Description
INDPLMB-KIT	Plumbing package for inductor tank 2" Hosebarb Inlet x 2" Hosebarb Outlet

INDUCTOR / EDUCTOR SYSTEMS

40 & 60 GALLON CLEANLOAD SYSTEMS

- 40 or 60 gallon tank
- Market leading eduction rates
- Dual CycloRinse nozzles
- ProClean bottle rinse
- 2" bypass plumbing for use with spray pumps
- 3" bypass plumbing for use with multiple Cleanloads
- Compact eductor and bypass assembly uses less space than competitor

HYPRO®



2" Bypass

3371-0044



3" Bypass

3371-0046

Part #	Description
3378-1640-2BYP	Transfer Pump, 40 Gallon, 16mm Eductor, 2" Bypass
3378-1660-3BYP	Transfer Pump, 60 Gallon, 16mm Eductor, 3" Bypass
3371-0044	2" Bypass, 11mm Eductor
3371-0046	3" Bypass, 16mm Eductor

HYPRO® 3376 SERIES CLEANLOAD

Eduction System for Quick and Safe Loading of Chemicals into Spray Tanks

- The Cleanload is a self-contained eduction system, which allows the operator the use of one system to mix liquid and dry chemicals safely and quickly
- 7.0 gallon (26.5 L) tank features a wide 16-inch lid (406 mm), holds a full 51 pound (23.1 kg) bag of dry material, and can be used to rinse larger 20-liter (5.2 gal) jugs
- Educts 7 gallons (26.5 L) of liquid in 10 seconds and a 51 pound (23.1 kg) bag of AMS in 30 seconds



Part #	Tank Size	Application	Eductor Orientation	Flange
3376-0870	7 Gallon	Turf/Diaphragm, Poly- (08mm) High Pressure/ Low Flow	Right Hand	220 Universal Flange
3376-1170	7 Gallon	On-Board Sprayer, Poly- (11mm) High Pressure/ High Flow	Right Hand	220 Universal Flange
3376-1171	7 Gallon	On-Board Sprayer, Poly- (11mm) High Pressure/ High Flow	Left Hand	220 Universal Flange
3376-1670	7 Gallon	Transfer Pump, Poly- (16mm) Low Pressure/ High Flow	Right Hand	220 Universal Flange
3376-1671	7 Gallon	Transfer Pump, Poly- (16mm) Low Pressure/ High Flow	Left Hand	220 Universal Flange
3375P-05T5	5.5 Gallon	316 Stainless Steel	Right Hand	1-1/4" x 1-1/2" Flynut ready
3375P-05T7	7 Gallon	316 Stainless Steel	Right Hand	1-1/4" x 1-1/2" Flynut ready

CLEANLOAD POLY OR STAINLESS STEEL EDUCTOR

Poly Eductor:



3371-0036

- Market leading eduction rates designed for real world applications
- Optimizes system plumbing Costs with an integrated 1/2" push-to-connect port for tank rinse
- One-piece polypropylene eductor assembly with mounting bosses and 220 Universal Flange ports
- Choose from three nozzle sizes along with right or lefthand push-to-connect orientation to fit your specific application

316 Stainless Steel Eductor:



3371-00345

- Inlet and outlet ports are flynut-ready, offering a wrenchfree connection of hoses for easy installation and servicing
- Dual-ported to accommodate rinse port for either left hand or right-hand flow orientation

Part #	Application	Nozzle	Orientation	Description
3371-0040	Transfer Pump: Low Pressure/High Flow	16 mm	Right Hand	Includes three 220 Universal Flange Gaskets, 1/2" Push-to-Connect plug
3371-0040R			Right Hand	Eductor Only
3371-0041R			Right Hand	Eductor Only

INDUCTOR / EDUCTOR SYSTEMS

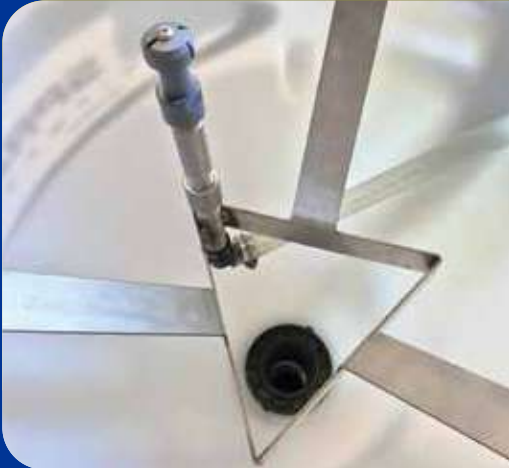

EZ INDUCTOR JUG RINSE

Drop in jug rinse system fits any Inductor tank with a 16" lid. Stainless Steel insert with 360 degree rotating rinse nozzle. Insert fits under tank lid. Kit includes: Stainless steel tank insert, rinse nozzle, 3/4" tank fitting and in tank plumbing.

<u>Part #</u>	<u>Description</u>
EZJR-16-KIT	EZ Inductor Tank Jug Rinse Kit, with rinse nozzle, fits under 16" lid.

CHEM-BLADE

The patented Chem-Blade Original opens, empties, and rinses chemical containers with unmatched speed and efficiency. Simply bring the bottom of chemical containers down onto the blades of the Chem-Blade Original splitting the jug and emptying the contents in mere seconds. No more tedious removal of caps and foil seals.



<u>Part #</u>	<u>Description</u>
CB0016	Chem-Blade original. Fits under 16" lid, with rinse nozzle



SLICER JUG RINSE KIT FOR INDUCTOR / EDUCTOR TANKS

Jug Rinse System Installs In Inductor Tank. Press The Chemical Jug Down On The Stainless Steel Tri-Blade Knife And Press The Rinse Valve Trigger To Rinse Your Jugs.

(Kit Includes Stainless Steel Slicer, Tank Fitting, Trigger Valve , Hose And Warning Stickers.)



<u>Part #</u>	<u>Description</u>
SLICER-KIT	Slicer With Plumbing

NORWESCO TANK LIDS

Part #	Description
62532	16" hinged lid with ring & vent
63390	16" hinged lid, ventless, w/o ring
60038	16" lid, ring and 4" center lid/air vent
60011	16" lid with 4" center lid/air vent
63485	16" lid with ring and vent
60365	16" lid, ventless
60367	16" lid, ventless with ring
60019	4" lid with air vent (air vent assembly for 16" lid)
60012	16" ring only
60032	8" lid, ring and air vent
60002	8" lid with air vent
60003	8" ring only for 60002
61727	Air vent for 8" lid only (snap on) 60002
60322	5" lid with ball check air vent (for tanks manufactured prior to 2/1/00)
63484	5" lid with ball check air vent (for tanks manufactured after 2/1/00)
62941	Ethafoam gasket for 16" non-hinged lid
60366	EPDM gasket for 5" lid, 60322, 63264, or 63484
63264	5" lid with 2" FPT, does not include vent cap
62531	Lanyard (18") for 8" or 16" non-hinged lid
67374	Strainer basket for 16" fillwell (7" depth)
63679	22" Lid and ring with air vent



62532



60038



63485



60011



60002



63485 (NEW STYLE)

POLYPROPYLENE VENT CAP/ANTI-VORTEX

Part #	Description
VC230	2" vent cap with 30 mesh screen
VC330	3" vent cap with 10 mesh screen
VC200	2" vent cap (without screen)
VC300	3" vent cap (without screen)

- 2" male NPT
- 304 SS screen
- Glass reinforced polypropylene



16" HINGED LOCKING LID 180°

Benefits:

- Lid stays secure
- Prevents collapsing under suction
- Prevents chemical spills & splashing
- Holds out in all weather conditions
- Interchangeable with standard 16" lid
- Polypropylene, chemical resistant



Part #	Description
HINGEDLID	16" hinged/locking lid
TLP-0023	16" gasket replacement

10" POLY THREADED LIDS



Part #	Description
TL101	10" non-vented tank lid
TR10	10" tank ring
TLA10	10" vented tank lid assy

NORWESCO DOUBLE THREADED TANK FITTINGS

Part #	Fitting Size	Hole Size
62834	1/2" heavy duty double threaded polypropylene fitting	1 7/16"
60401	3/4" double threaded polypropylene fitting	1 7/16"
62798	3/4" heavy duty double threaded polypropylene fitting	1 5/8"
60427	1" double threaded polypropylene fitting	2 1/4"
60403	1 1/4" double threaded polypropylene fitting	2 1/4"
63065	1 1/4" anti-vortex polypropylene fitting	2 1/4"
60124	1 1/2" double threaded polypropylene fitting	3"
60405	2" double threaded polypropylene fitting	3"
63683	2" heavy duty	3-1/4"
60335	2" siphon tube for 60337 & 60405	-
63481	2" standard duty double threaded polypropylene fitting	3"
62299	3" double threaded polypropylene fitting only	4 1/2"
62171	4" double threaded polypropylene fitting	5 3/4"
60327	3" siphon tube for 60339	-
62714	4" siphon tube for 62171	-
63263	3" x 12" long siphon tube	-



NORWESCO DOUBLE THREADED TANK GASKETS & PARTS

Part #	Fitting Size
60330	2" polypropylene reducer for 3" fitting
60402	1/2" & 3/4" EPDM gasket for 60401 & 62834
62799	3/4" EPDM gasket for 62798
60360	1/2" & 3/4" VITON gasket for 60401 & 62834
62800	3/4" VITON gasket for 62798
60404	1" & 1 1/4" EPDM gasket for 60427, 60403, & 63065
60361	1" & 1 1/4" VITON gasket for 60427, 60403, & 63065
60406	1 1/2" & 2" EPDM gasket for 60124, 60405, 61767 & 63481
60523	1 1/2" & 2" type B VITON gasket for 60124, 60405, 61767 & 63481
60336	2" EPDM gasket for 63683
60008	2" type B VITON gasket for 63683
60331	3" EPDM gasket for 60339 & 62299
60351	3" type B VITON gasket for 60339 & 62299
62785	4" EPDM gasket for 62171
62786	4" VITON gasket for 62171
61879	Poly Welding Kit, per foot
62398	1-1/4" Antivortex adapter for 60403
62399	2" Antivortex adapter for 60405 & 60337
60401GB	3/4" BUNA gasket for 60401
60403GB	1 1/4" BUNA gasket for 60403
60405GB	2" BUNA gasket for 60405
63316	2" MPT vent cap, anti-vortex, without screen



NORWESCO STAINLESS STEEL BOLT-IN TANK FITTINGS

Part #	Fitting Size
63233	3" stainless steel bolted fitting less gasket
63226	Viton gasket for 63233
63037	1 1/2" stainless steel bolted fitting less gasket
63038	2" stainless steel bolted fitting less gasket
63225	Viton gasket for 63037 & 63038





DOUBLE THREADED POLY TANK FITTINGS

Part #	Fitting Size	Hole Size
TF050	1/2" double threaded polypropylene fitting	1 5/8"
TF075	3/4" double threaded polypropylene fitting	1 5/8"
TF100	1" double threaded polypropylene fitting	2 1/4"
TF125	1 1/4" double threaded polypropylene fitting	2 1/4"
TF150	1 1/2" double threaded polypropylene fitting	3"
TF200	2" double threaded polypropylene fitting	3"
TF220	2" double threaded polypropylene fitting	3 1/4"
TF300	3" double threaded polypropylene fitting	4 1/2"
150G	3/4" EPDM gasket for TF050 & TF075	1 5/8"
200G	1" & 1 1/4" EPDM gasket for TF100 & TF125	2 1/4"
300G	1 1/2" & 2" EPDM gasket for TF150 & TF200	3"
TF220G	2" EPDM gasket for TF220	3 1/4"
TF300G	3" EPDM gasket for TF300	4 1/2"



"BOTTOM DRAIN" BOLTED TANK FITTINGS EPDM GASKET



VITON GASKETS AVAILABLE

Part #	Fitting Size
BF075BD	3/4" x 1 1/2" Threaded Flange
BF100BD	1" x 1 1/2" Threaded Flange
BF125BD	1 1/4" x 1 1/2" Threaded Flange
BF150BD	1 1/2" x 2" Std Port Threaded Flange
BF200BD	2" Threaded Std Port Flange
BF220BD	2" x 2" Threaded Full Port Flange
BF300BD	3" Threaded Flange

ANTI VORTEX TANK FLANGES



Part #	Fitting Size	Hole Size
TF100AV	1" Tank Flange Anti Vortex	2 1/4"
TF125AV	1 1/4" Tank Flange Anti Vortex	2 1/4"
TF150AV	1 1/2" Tank Flange Anti Vortex	3"
TF200AV	2" Tank Flange Anti Vortex	3"

BANJO DOUBLE THREADED STAINLESS STEEL TANK FITTINGS



- Double sided threads
- Standard with EPDM gaskets
- Viton gaskets available

Part #	Fitting Size	Hole Size
TF075/SS	3/4" double threaded Stainless Steel fitting	1 5/8"
TF100/SS	1" double threaded Stainless Steel fitting	2 1/4"
TF125/SS	1 1/4" double threaded Stainless Steel fitting	2 1/4"
TF150/SS	1 1/2" double threaded Stainless Steel fitting	3"
TF200/SS	2" double threaded Stainless Steel fitting	3"
TF220/SS	2" double threaded Stainless Steel fitting	3 1/4"
TF300/SS	3" double threaded Stainless Steel fitting	4 3/8"
150G	3/4" EPDM gasket for TF075	1 5/8"
200G	1" & 1 1/4" EPDM gasket for TF100 & TF125	2 1/4"
300G	1 1/2" & 2" EPDM gasket for TF150 & TF200	3"
TF220G	2" EPDM gasket for TF220	3 1/4"
TF300G	3" EPDM gasket for TF300	4 1/2"

STAINLESS STEEL BOLT-IN TANK FITTINGS

Features:

- 3/16" flange plates
- Stainless steel anti-vortex
- 304 stainless steel nipple
- Stainless steel bolts (welded in)
- Stainless steel lock washers and nuts
- Viton bolt gaskets
- EPDM flange gasket

Options:

- Viton gaskets
- Special fittings available on request

Advantages of Stainless Steel fittings

- Durable and strong
- Less chance of thread damage
- Able to withstand more weight due to plumbing hardware
- The fitting forms to the tank, not the tank to the fitting
- Requires NO special tools for installation
- The fitting CAN be reused

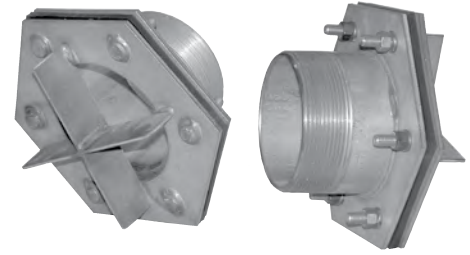

Part #	Size	Outside Flange	Inside Flange
2R3MX4E	3"	male	anti-vortex
2R4MX4E	4"	male	anti-vortex
3R6MX4E	6"	male	anti-vortex
1R2FX4E	2"	female	anti-vortex
2R3FX4E	3"	female	anti-vortex
2R4FX4E	4"	female	anti-vortex
2R3M3M4E	3"	male	male
2R4M4M4E	4"	male	male
1R2F90X4E	2"	female, 90° elbow	anti-vortex
2R3F90X4E	3"	female, 90° elbow	anti-vortex
2R4F90X4E	4"	female, 90° elbow	anti-vortex
2R3MXP4E	3"	male	high-flo anti-vortex
2R3FXP4E	3"	female	high-flo anti-vortex
3R6MX4E	6"	male	anti-vortex

SPECIALTY BOLTED STAINLESS STEEL TANK FITTINGS

316 stainless steel construction • Nipple welded to inside flange • HDPE gaskets • Other sizes and models are available

Part #	Description
TA-20-FC-SS	2" Full Coupling
TA-30-FC-SS	3" Full Coupling
TA-20-FN-SS	2" Full Nipple
TA-30-FN-SS	3" Full Nipple
TA-20-FC-SS-AV	2" Full Coupling Antivortex

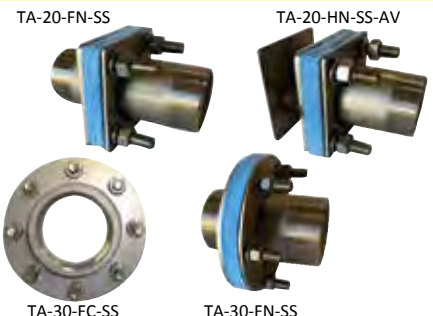

FLOW DIVIDERS/MANIFOLDS

Features Of The "Exacto-Flow" FD 1200 Flow Divider

- Revolutionary piston design insures unequaled accuracy
- Two or more CDS-John Blue Flow Dividers can be banked together for additional outlets while continuing to provide row-to-row precision
- Eliminates the need for orifices
- Higher tolerance of foreign materials than manifolds and orifices
- Field repairable-always calibrated equally
- 316 stainless steel body built to last a lifetime
- The "Exacto-Flow" is designed for precision farming variable rate technology of today and the future



FD-1210

Flow Dividers and Flow Divider Mounts

Part #	Description	# Of Outlets	Inlet	Outlet	Maximum Flow Per Outlet
FD-0610	"Exacto-Flo" Stainless Steel Flow Divider	6	3/4" FPT	1/4" FPT	2.25 GPM
FD-1210	"Exacto-Flo" Stainless Steel Flow Divider	12	3/4" FPT	1/4" FPT	2.25 GPM
FD-2000	"Exacto-Flo" Stainless Steel Flow Divider	20	1" FPT	1/4" FPT	2.25 GPM
113989	Flow Divider Mounting	N/A	N/A	N/A	N/A

Check Valves

115284-01	Check Valve-PVC, Viton Seal, 316 Ball, 1/4" Ball x 1/4" Hose, 1 PSI
115285-01	Check Valve-PVC, Viton Seal, 316 Ball, 3/8" Ball x 3/8" Hose, 1 PSI
115286-01	Check Valve-PVC, Viton Seal, 316 Ball, 1/2" Hose x 1/2" Hose, 1 PSI

CDS-JOHN BLUE INJECTION UNITS

CDS-John Blue Fertilizer Injection Units

Part #	Phase	Model Type	Low Range	High Range	Max PSI	Motor Size
IN-23530-NGP	Three	Simplex	3-32	12-119	120	3/4
		Duplex	6-64	24-235	120	3/4



20620



CDS-John Blue Series 2000 Simplex Pumps

Power Source	5-30	10-110
220-440 Three ph	20620	21630
12 Volt DC Motor	30620	30630

CDS-John Blue Series 2000 Duplex Pumps

Power Source	5-30 / 5-30	5-30 / 10-100	10-100 / 10-100
220-440 3 ph	20622	20623	20633
12 Volt DC Motor	-	30623	30633

MISTER MIST'R INJECTION CHECK VALVE

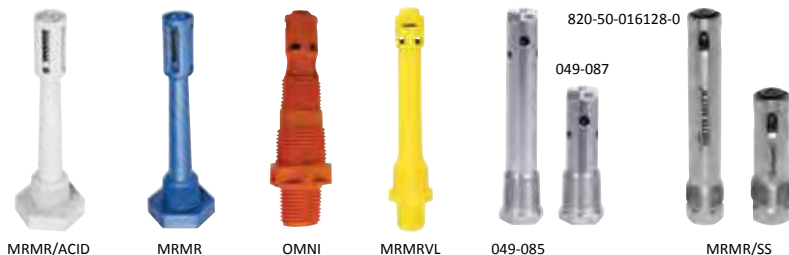

Part #	Description	PSI	Inlet Size	Max GPH
MRMR	Classic Mister Mist'r Check Valve, Poly	15 PSI	1/4" FPT Inlet	0.5 To 70 GPH
820-19-016032-0	Omni Mister Mist'r Check Valve, Poly 4"-Acid Ready	15 PSI	1/4" FPT Inlet	0.5 To 70 GPH
MRMR/ACID	Classic Mister Mist'r Check Valve - Acid Application	15 PSI	1/4" FPT Inlet	0.5 To 70 GPH
MRMRVL	Ultra Mister Mist'r Check Valve - Poly	15 PSI	1/2" MPT Inlet	3 To 110 GPH
049-085	Chemigation Check Valve - Stainless Steel 6"	50 PSI	1/2" FPT Inlet	To 200 GPH
049-087	Shorty Chemigation Check Valve - Stainless Steel 3"	50 PSI	1/2" FPT Inlet	To 200 GPH
MRMR/SS	Mister Mist'r Check Valve - Stainless Steel 8"	15 PSI	1/2" FPT Inlet	15 To 300 GPH
820-50-016128-0	Shorty Mister Mist'r Check Valve - Stainless Steel 4"	15 PSI	1/2" FPT Inlet	15 To 300 GPH

BLEEDER VALVE

Our bleeder valve has been designed to work hand in hand with the Mister Mist'r. The bleeder valve lets the user bleed out the lines and facilitates quick priming of the pump. Attaching a tube onto the outlet port allows you to direct and contain any product that is released.



821-02-008008-0

821-02-016000-0

821-02-016012-0

Part #	Description
821-02-008008-0	Classic Bleeder Valve Assembly, PP. 1/4" FPT X 1/4" MPT
821-02-016000-0	Bleeder Valve For 110 poly 1/2" MPT. Use up to 300 GPH 1/2" MPT X 1/2" FPT Elbow
821-02-016012-0	Bleeder Valve For 110 poly 3/8" Quick Connect. Use up to 110 GPH-3/8" Push-To-Connect X 1/2" FPT Elbow

INJECT-O-METER FERTILIZER PUMPS

IOM3301



- Stainless Steel wetted parts
- Viton O-rings
- Viton Vee-Packing
- Stainless Steel Check Valves
- Available in 30, 57, 100 GPH Units



IOM96-S



Part #	Description
IOM3301	SIMPLEX, 5-30 GPH, 3 PH; 3/8" MPT Inlet/Outlet
IOM96-S	SIMPLEX, 10-100 GPH, 3 PH; 1/2" MPT Inlet/Outlet

Part #	Description
HVI-88	SIMPLEX, INJECT-O-METER PUMP, 30 GPH; 3/8" MPT Inlet/Outlet
HVI-82	SIMPLEX, INJECT-O-METER Pump, 57 GPH; 1/2" MPT Inlet/Outlet

Contact Us



Need help selecting a [Nurse Trailer](#)? Call us for assistance!

We are here to serve you. Just call or email with your project specifications and details, and we'll do the rest. Our goal is to provide the best solution for your project, with materials delivered on time at a price that fits nicely within your budget.

For more complete information on One Clarion products and solutions, visit us on the Web at www.clarionmunicipal.com

Phone: (+1) 863-261-8388 | info@oneclarion.com

© 2024 One Clarion. All rights reserved. One Clarion terms and conditions apply.

All photos are representative only. Actual products may differ. Materials and specifications are subject to change without notice. Featured products in photos may include additional equipment or accessories.

Phone: (+1) 863-261-8388 | www.clarionmunicipal.com | info@oneclarion.com